

POLYSTEEL

1



CARROS DE  
AUTOSERVICIO  
METÁLICOS

DRAHTEINKAUFSWAGEN

*Marsanz*

ES DE

C R E A T I V I D A D

I N N O V A T I O N

I N V E S T I G A C I O N

F O R S C H U N G

D E S A R R O L L O

E N T W I C K L U N G

C A L I D A D

Q U A L I T Ä T

S E R V I C I O

D I E N S T L E I S T U N G E N

EDICION: ABRIL 2015

EDITION: APRIL 2015

# S U M A R I O

ESPECIFICACIONES CARRO DE AUTOSERVICIO	4 - 5
ESPECIFICACIONES RUEDAS CARROS DE AUTOSERVICIO	6 - 7
PRESENTACION CARRO AUTOSERVICIO	8 - 9
ACCESORIOS Y COMPLEMENTOS	10-11
MANGOS Y MONEDEROS	12-13

## CARROS DE AUTOSERVICIO -GAMA STANDARD-



25L. 50L. 60L.	14
80L. 100L.	15
120L. 140L.	16
150L. 160L.	17
180L. 210L.	18
212L. 240L.	19

## CARROS DE AUTOSERVICIO -GAMA ANTIHURTO-



80L. 100L.	20
120L. 140L.	21
150L. 160L.	22
180L. 210L.	23
212L. 240L.	24

## CARROS DE AUTOSERVICIO -GAMA ESPECIAL-



CARRO DE COMPRA LIGERA 80L. - 100L.	25
CARRO FRONTAL ABATIBLE 200L.	26
CARRO "T-M" 200L.	26
CARRO SKALATOR 120L. - 140L.	27
CARRO "EM" 140L.	28
CARRO ESPECIAL PARA SILLAS DE RUEDAS 62L	28
CARRO MULTICESTA	29
CESTA DE COMPRA 25L. - 50 L.	29

## CUADROS DE ACCESORIOS

CARROS DE AUTOSERVICIO "GAMA-STANDARD"	30
CARROS DE AUTOSERVICIO "GAMA-ANTIHURTO"	31
CARROS DE AUTOSERVICIO "GAMA-ESPECIAL"	32

CUBRE CARROS // PARKING CARROS	33-34
--------------------------------	-------

CERTIFICADO DE PRODUCTO	35
-------------------------	----

DIRECCIONES	36
-------------	----

# I N H A L T

TECHNISCHE SPEZIFIKATIONEN FÜR EINKAUFSWAGEN	4 - 5
TECHNISCHE SPEZIFIKATIONEN FÜR ROLLEN	6 - 7
PRÄSENTATION EINKAUFSWAGEN	8 - 9
VERSCHIEDENES ZUBEHÖR	10-11
HANDGRIFFE UND MÜNZPFANDSYSTEME	12-13

## EINKAUFSWAGEN -STANDARD LINIE-

25L. 50L. 60L.	14
80L. 100L.	15
120L. 140L.	16
150L. 160L.	17
180L. 210L.	18
212L. 240L.	19



## EINKAUFSWAGEN -DIEBSTAHLSCHUTZ LINIE-

80L. 100L.	20
120L. 140L.	21
150L. 160L.	22
180L. 210L.	23
212L. 240L.	24



## BESONDERE EINKAUFSWAGEN

EINKAUFSWAGEN LIGHT 80L. - 100L.	25
EINKAUFSWAGEN MIT FRONTKLAPPE 200L.	26
EINKAUFSWAGEN " T-M " 200L.	26
SKALATOR EINKAUFSWAGEN 120L. - 140L.	27
" E-M " EINKAUFSWAGEN 140L.	28
SPEZIELLER WAGEN FÜR ROLLSTÜHLE 62L	28
MEHRKORB EINKAUFSWAGEN	29
DRAHTHANDKÖRBE 25L. - 50 L.	29



## ZUBEHÖRTEILE ÜBERSICHT

EINKAUFSWAGEN -STANDARD LINIE-	30
EINKAUFSWAGEN -DIEBSTAHLSCHUTZ LINIE-	31
BESONDERE EINKAUFSWAGEN	32

PARKBOXEN // REIHENANFANGSSTATION FÜR EKW	33-34
PRODUKTZERTIFIKAT	35

ADRESSEN	36
----------	----



AENOR



Producto  
Certificado

A12 / 00001

UNE-EN 1929-1  
UNE-EN 1929-2  
UNE-EN 1929-3  
UNE-EN 1929-4  
UNE-EN 1929-7



## E S P E C I F I C A C I O N E S T É C N I C A S

### CARACTERÍSTICAS

Carros compuestos por un cesto para el transporte de mercancías, de una plataforma con ruedas, de un asa o mango y rejilla trasera simple o con portabebe. Nuestros cubicajes oscilan desde 25 litros hasta 240 litros.

### ACABADOS

Fabricados con materiales de primera calidad conforme a las Normas UNE EN 10016 / UNE EN 10305. Los diámetros que conforman su composición van desde 3 mm. hasta 14 mm. Uniones soldadas con penetraciones medias del 15% (según diámetro).

FABRICADOS DE ACUERDO A REQUISITOS CONFORME A UNE EN 1929-1 / UNE EN 1929-2 / UNE EN 1929-3 / UNE EN 1929-4 / UNE EN 1929-7

### REVESTIMIENTOS

Zincado: Tratamiento de Zinc electrolítico con un recubrimiento de  $10 \pm 20$  micras.

Recubrimiento: Electrostático de poliéster transparente de  $60 \pm 80$  micras polimerizado a  $200^\circ\text{C}$ .

Polipropileno Inyectado.

### PROPIEDADES QUÍMICAS

Niebla salina: ( ASTM B 117 ) > 700 h.

Cámara de humedad: ( DIN 50017 ) > 1000 h.

Inmersión Agua Destilada: (  $40^\circ\text{C}$  ) > 700 h.

### PROPIEDADES MECÁNICAS

Brillo 60 ( DIN 53151 ) 100%

Adherencia (cuadrícula 2 mm.) 100%

Dureza ( Lápiz INTA 160302 - 2 ) > 3 h.

Resistencia al impacto ( ASTM D 2974 ) Bola 12 mm.

Directo 70 cm.

Inverso 70 cm.

Dureza Persoz > 300

Flexibilidad Mandril Cónico ( DIN 53156 ) 5 mm.

Los ensayos Químicos como Mecánicos se han realizado sobre probetas de acero fosfatado microcristalino ( BONDER 132 ) con un espesor de aplicación de  $50 \pm 60 \mu$ . y polimerizado a  $200^\circ\text{C}$ .

### CONFORT, ERGONOMÍA Y SEGURIDAD

Cumpliendo todos los requisitos de confort, ergonomía y seguridad conforme a UNE-EN 1929-1 / UNE-EN 1929-2 / UNE-EN 1929-3 / UNE-EN 1929-4 / UNE-EN 1929-7.

### MANGO ERGOBOX Y MANGO OVAL ERGOGRIP

Polipropileno inyectado con protección contra radiación UV.,

Material resistente a ácidos, detergentes y soluciones salinas, exento de incompatibilidad electromagnética.

### MANGO REDONDO

Fabricado en tubo de acero galvanizado de primera calidad, con embuticiones en los extremos para evitar su giro, recubierto con papel plastificado para serigrafía personalizada y con funda de policarbonato para mayor protección u.v.

Laterales de la empuñadura fabricados en P.V.C. de gran resistencia, con nervaduras laterales y equipados con casquillos y tornillos, asegurando un perfecto anclaje del mango al propio carro.





## T E C H N I S C H E S P E Z I F I K A T I O N E N

### EIGENSCHAFTEN

Unsere Einkaufswagen bestehen aus einem Drahtkorb für den Transport von Waren; aus einem Fahrgestell mit Rollen; aus einem Griff; und aus einer normalen hinteren Ablage oder einem Kindersitz. Korbvolumen von 25 bis 240 L.

### FINISH

Mit hochwertigen Materialien gefertigt, gemäß der Europäischen Standards UNE EN 10016 / UNE EN 10303. Stahl Drahtstärke von 3 bis 14 mm Durchmesser. Schweißverbindungen mit durchschnittliche Eindringen von 15% (je nach Durchmesser). Nach Standards UNE EN 1929-1 / prEN 1929-2/ prEN 1929-3 / prEN 1929-4 / prEN1929-7 gefertigt.

### BESCHICHTUNG

Verzinkung: elektrolytische Verzinkung mit einer Beschichtung von 10 bis 20 Mikrometer dicker.  
Beschichtung: Transparent Kunststoff-Lack-Schutz von 60 bis 80 Mikrometer bei 200 ° C polymerisiert.  
Polypropylen-Spritzguss

### CHEMISCHE BESTÄNDIGKEIT

Salzsprühstest (ASTM B 117)> 700 Stunden.  
Feuchtigkeit Prüfkammer: (DIN 50017)> 1000 Stunden.  
Destilliertes Wasser Tauchen (40 ° C)> 700 Stunden.

### MECHANISCHE EIGENSCHAFTEN

HELLIGKEIT 60 (DIN 50017), 100%  
HAFTREIBUNG (Raster 2 mm.) 100%  
HÄRTE (PENCIL-PROOF INTA 160.302-2)> 3 Stunden  
SCHLAGZÄHIGKEIT (ASTM D 2974) BALL 12 mm.  
DIREKT 70 CM.  
KEHRWERT 70 CM.  
PERSOZ-HÄRTE> 300  
FLEXIBILITÄT KONISCHE SPANNFUTTER (DIN 53156) 5 mm.

Chemische und mechanische Prüfungen waren mit bei 200°C polymerisiertem mikrokristallinem phosphatiertem Stahlrohr (BONDER 132) mit einem Schichtdicke von 50-60 Mikrometer durchgeführt.

### KOMFORT, ERGONOMIE UND SICHERHEIT

Alle Einkaufswagen erfüllen alle Anforderungen in Bezug auf Ergonomie, Komfort und Sicherheit, gemäß den Normen UNE-EN 1929-1 / UNE-EN 1929-2 / UNE-EN 1929-3 / UNE-EN 1929-4 / UNE-EN1929-7.

### ERGOBOX UND ERGOGRIFF GRIFF

Polypropylen-Spritzguss vor UV-Strahlung geschützt.  
Beständigkeit gegen Säuren, Reinigungs- und Salzlösungen, frei von elektromagnetischen Inkompatibilität.

### RUNDROHRGRIFF

Verzinktes hochwertiges Stahlrohr, mit seitlichen Einsätzen, um den Dreh des Griffes zu vermeiden.  
Handgriff mit Kunststoffbeschichtetes Papier für den personasilerten Siebdruck, und mit einem Polycarbonat-Hülle für einen besseren UV-Strahlung Schutz.  
Seiten des Griffes aus beständigem PVC Material, mit seitlicher Ripperstruktur, und mit Schrauben montiert, damit den Handgriff eine perfekte Verankerung an dem Einkaufswagen hat.



### RUEDA GIRATORIA 75 Ø

Rueda giratoria, soporte de chapa de acero, zincado cromatizado, rodamiento giratorio de dos hileras de bolas, eje de rueda atornillado, núcleo de rueda de polipropileno, bandaje de goma termoplástica, gris, sin dejar huella, con placas anti-hilos, cojinete plano, buje de taladro liso.

- Diámetro de rueda - 75 mm.
- Ancho de la rueda - 25 mm.
- Agujero pasante - 10.3 mm.
- Desplazamiento - 30 mm.
- Diámetro del radio giratorio - 135 mm
- Altura total - 100 mm.
- Capacidad de carga - 75 kg./ daN
- Capacidad de carga estática - 150 kg / daN
- Temperatura - 20 / + 60°C
- Norma - EN 12530
- Peso de la rueda - 0.301 kg. / daN

### 75 Ø LENKROLLEN

Lenkrolle, Gehäuse aus Stahlblech, glanzverzinkt blaupassiviert, Schwenklager mit zweifachem Kugelkranz, Radachse verschraubt, Anschraubloch. Radkörper aus Polypropylen, Lauffläche aus Thermoplastischer Gummi, grau-spurlos, Präzisionskugellager, mit Fadenschutz.

- Rad-Ø - 75 mm.
- Reifenbreite - 25 mm.
- Rückenloch - 10.3 mm.
- Ausladung - 30 mm.
- Störkreis-Ø - 135 mm
- Bauhöhe - 100 mm.
- Tragfähigkeit - 75 kg./ daN
- Tragfähigkeit (statisch) - 150 kg / daN
- Temperaturbereich - 20 / + 60°C
- Norm - EN 12530
- Eigengewicht - 0.301 kg. / daN

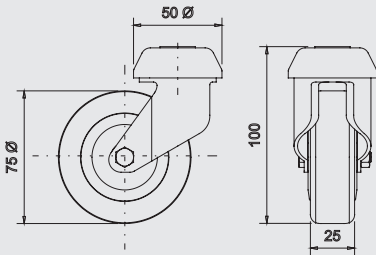

### RUEDA GIRATORIA 100 Ø

Rueda giratoria, soporte de chapa de acero, zincado cromatizado, rodamiento giratorio de dos hileras de bolas, eje de rueda atornillado, núcleo de rueda de polipropileno, bandaje de goma termoplástica, gris, sin dejar huella, con placas anti-hilos, conjinete de rodillos.

- Diámetro de rueda - 100 mm.
- Ancho de la rueda - 32 mm.
- Agujero pasante - 11 mm.
- Desplazamiento - 35 mm.
- Diámetro del radio giratorio - 170 mm
- Altura total - 129 mm.
- Capacidad de carga - 80 kg./ daN
- Capacidad de carga estática - 160 kg / daN
- Temperatura - 20 / + 60°C
- Norma - EN 12530
- Peso de la rueda - 0.534 kg. / daN

### 100 Ø LENKROLLEN

Lenkrolle, Gehäuse aus Stahlblech, glanzverzinkt, blaupassiviert, Schwenklager mit zweifachem Kugelkranz, Radachse verschraubt, Anschraubloch. Radkörper aus Polypropylen, Lauffläche aus Thermoplastischer Gummi, grau-spurlos, mit Kunststoff-Fadenschutz, Rollenlager.

- Rad-Ø - 100 mm.
- Reifenbreite - 32 mm.
- Rückenloch - 11 mm.
- Ausladung - 35 mm.
- Störkreis-Ø - 170 mm
- Bauhöhe - 129 mm.
- Tragfähigkeit - 80 kg./ daN
- Tragfähigkeit (statisch) - 160 kg / daN
- Temperaturbereich - 20 / + 60°C
- Norm - EN 12530
- Eigengewicht - 0.534 kg. / daN

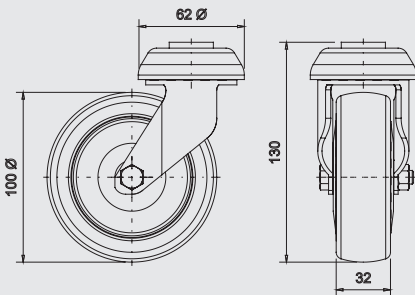

### RUEDA GIRATORIA 125 Ø

Rueda giratoria, soporte de chapa de acero, zincado cromatizado, rodamiento giratorio de dos hileras de bolas, eje de rueda atornillado, núcleo de rueda de polipropileno, bandaje de goma natural, gris, sin dejar huella, con placas anti-hilos, conjinete de bolas de precisión.

- Diámetro de rueda - 125 mm.
- Ancho de la rueda - 32 mm.
- Agujero pasante - 13 mm.
- Desplazamiento - 38 mm.
- Diámetro del radio giratorio - 201 mm
- Altura total - 155 mm.
- Capacidad de carga - 100 kg./ daN
- Capacidad de carga estática - 200 kg / daN
- Temperatura - 20 / + 60°C
- Norma - EN 12530
- Peso de la rueda - 0.661 kg. / daN

### 125 Ø LENKROLLEN

Lenkrolle, Gehäuse aus Stahlblech, glanzverzinkt, blaupassiviert, Schwenklager mit zweifachem Kugelkranz, Radachse verschraubt, Anschraubloch. Radkörper aus Polypropylen, Lauffläche aus Thermoplastischer Gummi, grau-spurlos, Präzisionskugellager, mit Fadenschutz.

- Rad-Ø - 125 mm.
- Reifenbreite - 32 mm.
- Rückenloch - 13 mm.
- Ausladung - 38 mm.
- Störkreis-Ø - 201 mm
- Bauhöhe - 155 mm.
- Tragfähigkeit - 100 kg./ daN
- Tragfähigkeit (statisch) - 200 kg / daN
- Temperaturbereich - 20 / + 60°C
- Norm - EN 12530
- Eigengewicht - 0.661 kg. / daN

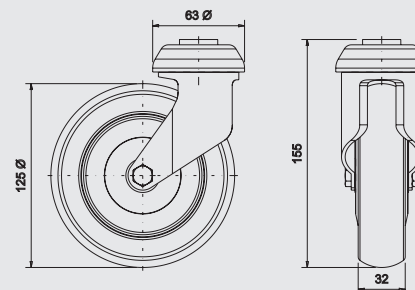



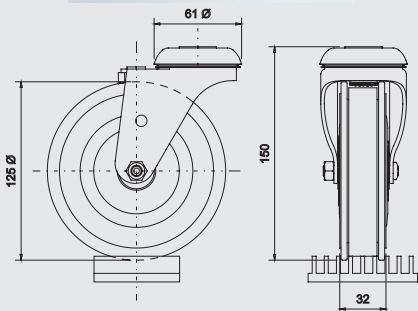

RUEDA GIRATORIA 125 Ø  
RAMPA FRENO CENTRAL

Rueda giratoria, soporte de chapa de acero, zincado cromatizado, rodamiento giratorio de dos hileras de bolas engrasada, anillo protector de plástico, eje de rueda atornillado, doble perfil de poliuretano sobre un eje de cojinete de bolas sellado. Los perfiles llevan un anillo interior de goma dura que empuja sobre un tope de goma de frenado cuando los perfiles entran en las pestañas de rampa.

Indicación: El uso en superficies irregulares y exteriores, puede afectar a la durabilidad y la funcionalidad de las ruedas.

- Diámetro de rueda - 125 mm.
- Ancho de la rueda - 32 mm.
- Agujero pasante - 12,4 mm.
- Desplazamiento - 40 mm.
- Diámetro del radio giratorio - 205 mm
- Altura total - 150 mm.
- Capacidad de carga - 120 kg./ daN
- Capacidad de carga estática - 180 kg / daN
- Temperatura - 20 / + 60°C
- Norma - DIN EN 12530
- Peso de la rueda - 0.748 kg. / daN

125 Ø FAHRSTEIGROLLE  
MIT ZENTRALER BREMSE

Fahrsteigrollen, Gehäuse aus Stahlblech, glanzverzinkt, Schwenklager mit zweireihigem Kugellauf.

**HINWEIS:** Der Einsatz auf unebenen Böden im Außenbereich kann die Funktion und Lebensdauer der Rolle beeinträchtigen.

- Rad-Ø - 125 mm.
- Reifenbreite - 32 mm.
- Rückenloch - 12,4 mm.
- Ausladung - 40 mm.
- Störkreis-Ø - 205 mm
- Bauhöhe - 150 mm.
- Tragfähigkeit - 120 kg./ daN
- Tragfähigkeit (statisch) - 180 kg / daN
- Temperaturbereich - 20 / + 60°C
- Norm - EN 12530
- Eigengewicht - 0.748 kg. / daN

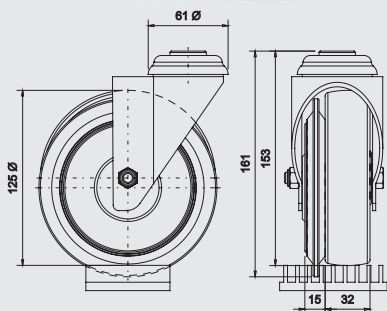

RUEDA GIRATORIA 125 Ø  
RAMPA FRENO DE DISCO

Rueda de rampa con freno automático de rueda, soporte de chapa de acero, zincado cromatizado, rodamiento giratorio de dos hileras de bolas, eje de rueda atornillado, ruedas con disco de freno integrado girando sobre una hilera de bolas, modelo de mano izquierda y derecha. Diseñado para funcionar en las siguientes medidas de rampa: ancho de ranuras: aprox.:2,75 mm., distancia entre las ranuras: aprox.:5,7 mm., profundidad de las ranuras: > 10 mm. Utilizar en superficies llanas.

Indicación: El uso en superficies irregulares y exteriores, puede afectar a la durabilidad y la funcionalidad de las ruedas.

- Diámetro de rueda - 125 mm.
- Ancho de la rueda - 32 mm.
- Agujero pasante - 12,3 mm.
- Desplazamiento - 40 mm.
- Diámetro del radio giratorio - 211 mm
- Altura total - 153 mm.
- Capacidad de carga - 100 kg./ daN
- Capacidad de carga estática - 250 kg / daN
- Temperatura - 20 / + 60°C
- Norma - DIN EN 12530
- Peso de la rueda - 0.853 kg. / daN

125 Ø FAHRSTEIGROLLE  
MIT RADSCHLEIBEN - BREMSE

Fahrsteigrolle mit automatischer Radfeststellung für Fahrsteige mit Paletten, seitliches Spurrad mit einfachem Kugelkranz, linke und rechte Ausführung, Gehäuse aus Stahlblech, glanzverzinkt, blaupassiviert, Schwenklager mit zweifachem Kugelkranz, Radachse verschraubt, Radkörper aus Kunststoff, Lauffläche aus Gummi, mit Fadenschutz, Präzisionskugellager.

Abgestimmt auf die Palettenmaße: Stegbreite: ca. 2,75 mm, Nutbreite ca. 5,7 mm, Nuttiefe > 10 mm.

**HINWEIS:** Der Einsatz auf unebenen Böden im Außenbereich (Bodenschwellen, Fugen, Kanaldeckel usw.) kann die Funktion und Lebensdauer der Rolle beeinträchtigen.

- Rad-Ø - 125 mm.
- Reifenbreite - 32 mm.
- Rückenloch - 12,3 mm.
- Ausladung - 40 mm.
- Störkreis-Ø - 211 mm
- Bauhöhe - 153 mm.
- Tragfähigkeit - 100 kg./ daN
- Tragfähigkeit (statisch) - 250 kg / daN
- Temperaturbereich - 20 / + 60°C
- Norm - EN 12530
- Eigengewicht - 0.853 kg. / daN

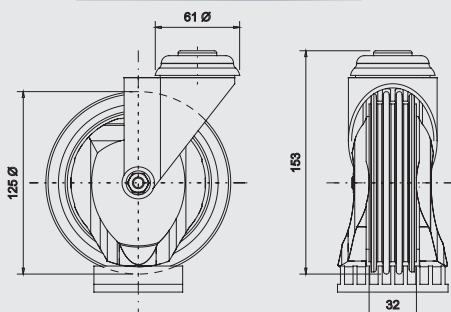

RUEDA GIRATORIA 125 Ø  
RAMPA DOBLE FRENO LATERAL

Rueda de rampa con patas de freno integradas, anti-hilos. Soporte de chapa de acero, zincado cromatizado, rodamiento giratorio de dos hileras de bolas, eje de rueda atornillado, núcleo de rueda de poliuretano, bandeja de poliuretano, 4 ranuras, autolimpiante entre las ranuras, con placas anti-hilos, cojinetes de bolas de precisión, distancia entre las ranuras: aprox. 4,5 mm., ancho de la ranura: 4 mm. Diseñado para funcionar en las siguientes medidas de rampa: ancho de ranuras: aprox.:2,75 mm., distancia entre ranuras: aprox.5,7 mm. profundidad de las ranuras: > 10 mm. Utilizar Superficies llanas.

INDICACION: El uso en superficies irregulares y exteriores, puede afectar a la durabilidad y la funcionalidad de las ruedas.

- Diámetro de rueda - 125 mm.
- Ancho de la rueda - 32 mm.
- Agujero pasante - 12,3 mm.
- Desplazamiento - 40 mm.
- Diámetro del radio giratorio - 205 mm
- Altura total - 153 mm.
- Capacidad de carga - 80 kg./ daN
- Capacidad de carga estática - 200 kg / daN
- Temperatura - 40 / + 60°C
- Norma - DIN EN 12530
- Peso de la rueda - 0.645 kg. / daN

125 Ø FAHRSTEIGROLLE  
MIT DOPPEL SEITLICHEM BREMSSTEG

Fahrsteigrolle mit seitlichem Bremssteg für Fahrsteige mit Paletten. Beidseitiger Fadenschutz mit integriertem Bremsfuß (Aufsetzfunktion), Gehäuse aus Stahlblech, glanzverzinkt, blaupassiviert, Schwenklager mit zweifachem Kugelkranz, Radachse verschraubt, Radkörper aus Polyurethan, Lauffläche aus Polyurethan, 4 Laufringe, Selbstreinigungsfunktion zwischen den Laufringen, mit Fadenschutz, Präzisionskugellager, Abstand zwischen den Laufringen: ca. 4,5 mm, Laufringbreite: ca. 4,0 mm.

Abgestimmt auf die Palettenmaße: Stegbreite: ca. 2,75 mm, Nutbreite ca. 5,7 mm, Nuttiefe > 10 mm.

**HINWEIS:** Der Einsatz auf unebenen Böden im Außenbereich kann die Funktion und Lebensdauer der Rolle beeinträchtigen.

- Rad-Ø - 125 mm.
- Reifenbreite - 32 mm.
- Rückenloch - 12,3 mm.
- Ausladung - 40 mm.
- Störkreis-Ø - 205 mm
- Bauhöhe - 153 mm.
- Tragfähigkeit - 80 kg./ daN
- Tragfähigkeit (statisch) - 200 kg / daN
- Temperaturbereich - 20 / + 60°C
- Norm - EN 12530
- Eigengewicht - 0.645 kg. / daN



C A R R O   D E   A U T O S E R V I C I O

*Marsanz*

NUESTROS NUEVOS CARROS ESTAN PREPARADOS PARA SATISFACER TODAS LAS EXIGENCIAS DEL NUEVO MERCADO.

UNSERE EINKAUFSWAGEN ERFÜLLEN ALLE ANFORDERUNGEN, DIE DER MARKT HEUTE UND ZUKÜNFTIG STELLT.

SU RESISTENCIA, ROBUSTEZ Y DURABILIDAD, HA LOGRADO HACER DE MARSANZ UNA MARCA DE REFERENCIA.

DURCH IHRE HALTBARKEIT, IHRE ROBUSTHEIT UND IHRE BESTÄNDIGKEIT, HAT MARSANZ ERZIELT, EINE REFERENZMARKE ZU SEIN.



OFRECIENDO UNA AMPLIA GAMA DE ACCESORIOS, CONSEGUIMOS CUBRIR TODAS LAS NECESIDADES EXIGIDAS POR NUESTROS CLIENTES.

WIR BIETEN EINE BREITE PRODUKTPALETTE AN, UM DIE BEDÜRFNISSE ALLER UNSEREN KUNDEN ZU ERFÜLLEN.





D R A H T E I N K A U F S W A G E N

*Marsanz*



COMODIDAD Y SEGURIDAD  
LA TRANQUILIDAD DEL PERFECTO  
ACABADO

SICHERHEIT UND KOMFORT: DIE  
BERUHIGUNG DER PERFEKTER  
VERARBEITUNG



LOS NUEVOS DISEÑOS HACEN DE SU EN-  
SAMBLAJE UNA NUEVA  
ESTETICA, MANIOBRABILIDAD, COLORIDO,  
MODERNIDAD.  
UN MAYOR DINAMISMO  
EN SU COMPRA

EINFACH ZU BEWEGEN, EINE GROÙE  
AUSWAHL VON FARBEN... UNSERE NEUE  
DESIGNS BESORGEN DEM EINKAUFSWAGEN  
EIN MODERNES AUSSEHEN.



AMPLIA GAMA DE  
COLORES A PETICION DE NUESTROS  
CLIENTES

GROÙE AUSWAHL VON FARBEN AUF  
ANFRAGE





SEPARADOR DE CESTO



QUERTRENNGITTER



La solución ideal para la ubicación de productos frágiles.

Die beste Lösung für empfindliche Produkte.

Solución para la ubicación de pequeños productos y frágiles.

Die beste Lösung für kleine und empfindliche Produkte.

SEPARADOR DE CESTA PEQUEÑO



DRAHTSCHALE



Además de mejorar la estética del producto, las esquinas superiores y el perfil plástico del bastidor prolongan la vida útil del carro.

CANTONERAS Y PROTECCIONES DE CESTO  
KORBSCUTZECKEN UND KORBSCUTZPROFIL



Diese Korbschutze wurden nicht nur entwickelt, um das Aussehen des Produktes zu verbessern, sondern auch um ihr Lebensdauer zu verlängern.

Solución para el aprovechamiento de carga de la plataforma estándar. La inclinación de la parrilla facilita la encajabilidad del producto.

Zusätzliche Ladekapazität für die Standardlinie-Einkaufswagen. Mit der Inklination der Drahtplattform schieben sich die Einkaufswagen perfekt ineinander.

REJILLA PLATAFORMA

DRAHTPLATTFORM





Disponiendo de una amplia gama de colores para los carros de varilla.

Garantizando una calidad de protección excelente, gracias al tratado metálico de zinc, recubrimiento de poliéster de color y finalmente el barniz sintético.

Grosse Auswahl von farbige Pulverbeschichtung für die Drahteinkaufswagen.

Hochglanzverzinkung, farbig pulverbeschichtete Oberfläche, Kunststoff-Lack-Schutz. Das perfekte Finish.

CARROS EN COLOR

FARBIGE EINKAUFSWAGEN

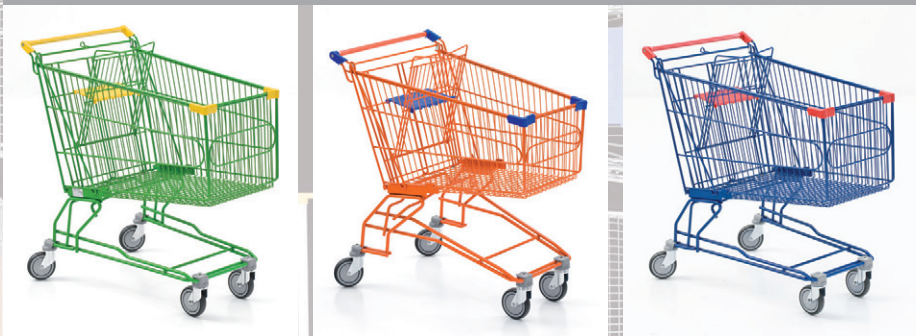

PORTA-BEBE DOBLE FUNCION

KINDERSITZ - WARENABLAGE

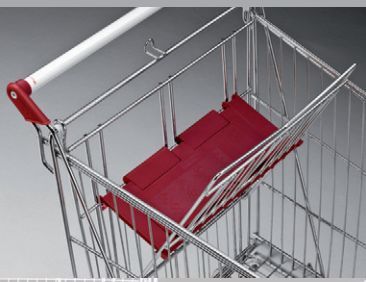

Gracias a la parrilla situada debajo del asiento de plástico, permite la carga adicional de producto, ideal para el transporte de productos delicados.

Kindersitz mit Klappenelement, um eine Kleinartikelschale zu haben.

DOBLE PORTA-BEBE  
ZWILLING KINDERSITZ



Solución óptima para la ubicación de dos niños.

Perfekte Lösung für 2 Kinder

PICTOGRAMAS DE ADVERTENCIAS  
KINDERSITZ MIT WARNHINWEISEN



Un sitio ideal para la ubicación de advertencias del correcto uso del carro.

Für eine richtige Verwendung des Einkaufswagens.

GAMA COLORES PARA LATERALES DE MANGO Y ASIENTOS PORTA-BEBE

STANDARD FARBEN FÜR DIE KUNSTSTOFFTEILEN UND FÜR DIE KINDERSITZ

RAL 1023



RAL 6028



RAL 2004



RAL 5005



RAL 7001



RAL 6018



RAL 3011



RAL 1028



NEGRO BLACK



RAL 3020





CUNA DE CESTO  
BABYSCHALE



Su perfecto diseño así como los materiales empleados, hace de la cuna el asiento ideal para el bebé, sin llegar a restar capacidad de carga al propio carro.

Ausgezeichnete Qualität der Babyschale für den Komfort Ihres Babys. Die Korbkapazität ändert sich nicht.

PORTACARTEL PUBLICITARIO  
PLAKATRAHMEN



Una forma sencilla de incrementar la rentabilidad de su carro, así como un método muy directo de impacto publicitario.

Die einfachste Methode, um die Rentabilität des Einkaufswagens zu erhöhen, und die Aufmerksamkeit der Kunden zu lenken.

SOPORTE PARA CUNA

BABY SCHALENKORB



Perfecto complemento para cualquier tipo de cuna.

Perfekt für jede Babyschale.

GANCHO CUELGA-BOLSOS

TASCHENHAKEN



Complemento del cesto que permite tanto la ubicación de productos embolsados como elementos personales.

Aus beständigem Kunststoff gefertigt.  
Geeignet für persönliche Taschen, Einkaufstaschen...

RACK BOTELLERO FIJO

STARRE KISTENABLAG



El rack botellero más sencillo. Ensamblado de forma fijo a la cesta.

Einfache starre Kistenablage.



Fácil de abatir es el accesorio idóneo para transportar las cajas de líquidos o botelleros.

Einfach zu öffnen, wenn notwendig.  
Geeignet für Getränkekisten,  
Waschmittelkartons...

RACK BOTELLERO PLEGABLE

AUSGEKLAHPTE KISTENABLAG







MANGO "ERGOBOX" GRIFF  
MEBM

Nuestro mango ERGOBOX de gran robustez ha sido el resultado de un minucioso estudio de ergonomía, consiguiendo con el diseño de su empuñadura un manejo mucho más cómodo del propio carro, ofreciendo un gran espacio para publicidad o para su marca.

Unser Griff ERGOBOX ist das Ergebnis einer eingehenden Studie über Ergonomie. Dieser Griff ist viel bequemer für die Kunden und bietet größerer Raum für Werbung oder für Ihre Marke.



SOPORTE SCANNER DE MANO "ERGOBOX"  
SCANNER HALTERUNG FÜR "ERGOBOX"  
SSE



LUPA PLEGABLE "ERGOBOX"  
KLAPPBARER LUPENGLAS  
LPMEBX



ORIGINAL PARA REPRODUCCION  
ORIGINAL FÜR PERSONALISIERTEN GRIFF  
ORL

LOGOTIPO PARA MANGO  
PERSONALISIERTER GRIFF  
LMC

ORIGINAL PARA REPRODUCCION "ERGOGRIP"  
ORIGINAL PERSONALISIERTER GRIFF "ERGOGRIP"  
ORL-E

LOGOTIPO PARA MANGO "ERGOGRIP"  
PERSONALISIERTER GRIFF "ERGOGRIP"  
LMC-E



MANGO ERGOGRIP (OVAL) Y MANGO REDONDO (STANDARD)  
ERGOGRIP GRIFF (OVAL) UND RUNDROHRGRIFF (STANDARD)



SOPORTE SCANNER INDIVIDUAL  
EINZEL SCANNER HALTERUNG  
SSIND



PROMOBOX MANGO REDONDO  
PROMOBOX FÜR RUNDROHRGRIFF  
PMMR

PROMOBOX MANGO OVAL  
PROMOBOX FÜR OVAL GRIFF  
PMMO

La manera más simple de darle mayor espacio publicitario, tanto para el mango oval como para el redondo.

Eine einfache Lösung für eine größere Werbefläche. Verfügbar für Rundrohr- und Ovalgriff.



VARILOC  
MCVH

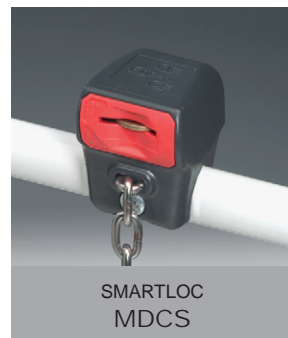

SMARTLOC  
MDCS

Metal para situaciones extremas. Sumamente resistente, robusto e inoxidable. Material: cinc colado a presión y recubierto de polvo.

Pfandschloss für extreme Belastungen. Gehäuse und Klemmteil sind aus Metall und damit besonders widerstandsfähig. Material: Hochfeste Pulverbeschichtung und Zinkdruckguss.

Fabricado en plástico muy robusto de alta calidad que asegura un funcionamiento sencillo y seguro facilitando el montaje.

Das smartloc kombiniert Robustheit mit kompakter Bauweise. Mit seiner schmalen Bauform bietet das Smartloc wenig Angriffsfläche für Vandalismus.



EUROLOC MANGO REDONDO  
EUROLOC FÜR RUNDROHRGRIFF  
MCSEURR

EUROLOC MANGO OVAL  
EUROLOC FÜR OVAL GRIFF  
MCSEURO

Fabricado en plástico de gran resistencia, su posicionamiento en el lateral del carro facilita una mayor superficie de publicidad y de agarre. Acoplable tanto al mango oval como al redondo.

In die Form des Einkaufswagens integriert. Das einteilige Gehäuse ist nicht nur ergonomisch geformt sondern auch extrem widerstandsfähig. Passend für Oval- und Rundrohrgriff.



CADENA INICIAL 1 mts.  
STARTERKETTEN 1 mts.  
CI-S1

INFANTIL  
KINDEREINKAUFSWAGEN

25 L.



50 L.

MINI-CARRO  
MINI-EKW



60 L.

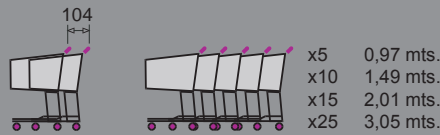
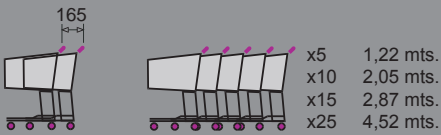
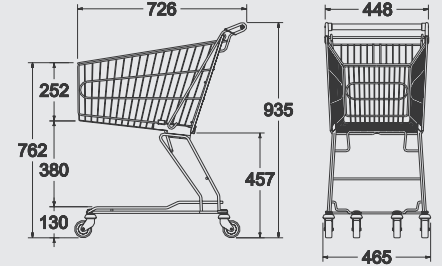
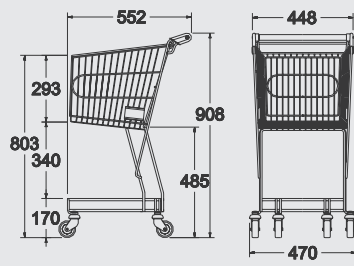
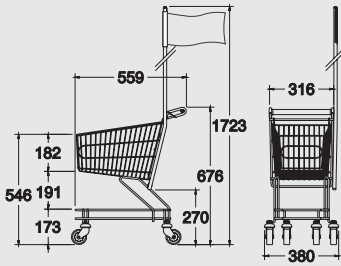

R U E D A S  
R O L L E N



25

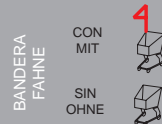

CASCB02501  
6,45 kg.

CASSB02501  
5,55 kg.

50

CASSP05001  
8,50 kg.

60

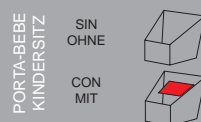

CASSP06001  
11,4 kg.

CASCP06001  
12,9 kg.



80 L.



100 L.

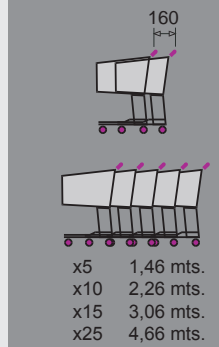
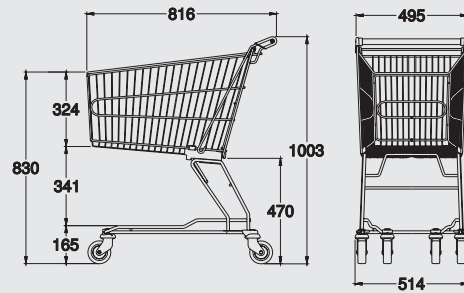
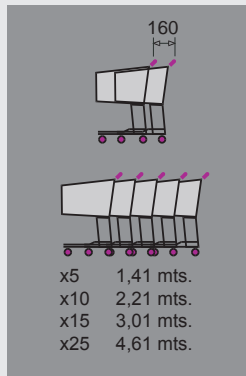
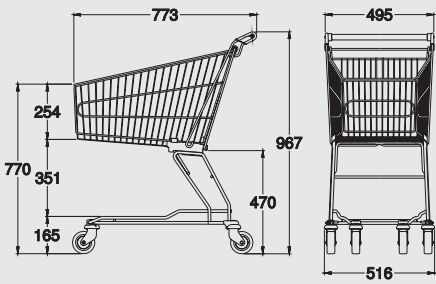

R U E D A S  
R O L L E N



80

PORTA-BEBE  
KINDERSITZ

SIN  
OHNE



CASSP08001  
13,35 kg.

CASSP08002  
14,35 kg.

CON  
MIT



CASCP08001  
14,85 kg.

CASCP08002  
15,85 kg.

100

PORTA-BEBE  
KINDERSITZ

SIN  
OHNE



CASSP10002  
15,35 kg.

CON  
MIT



CASCP10002  
16,85 kg.

# 120L.

# 140 L.

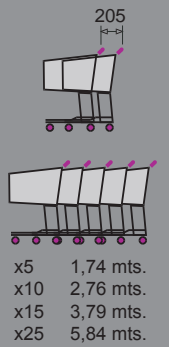
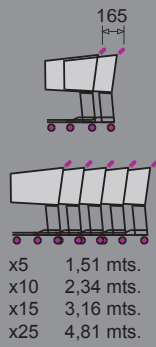
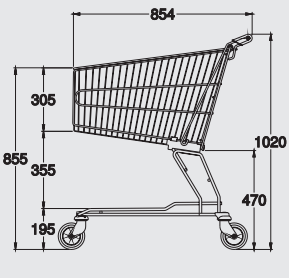

## RUEDAS ROLLEN



# 120

PORTA-BEBE  
KINDERSITZ

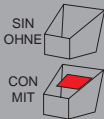

CASSP12003  
17,75 kg.

CASCP12003  
19,25 kg.

# 140

PORTA-BEBE  
KINDERSITZ

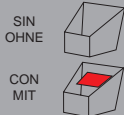

CASSP14003  
21,6 kg.

CASCP14003  
23.10 kg.

CASSP14006  
21,8 kg.

CASCP14006  
23,3 kg.

CASSP14007  
22,2 kg.

CASCP14007  
23,7 kg.

CASSP14008  
21,6 kg.

CASCP14008  
23.10 kg.



150 L.

PLATAFORMA GRAN CARGA  
PLATTFORM MIT ERHÖHTER LADENKAPAZITÄT



160 L.

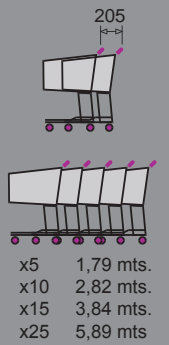
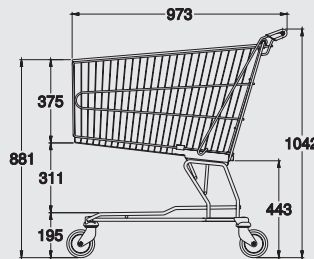
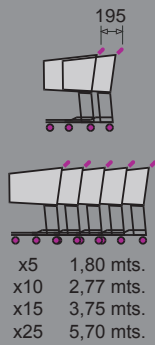
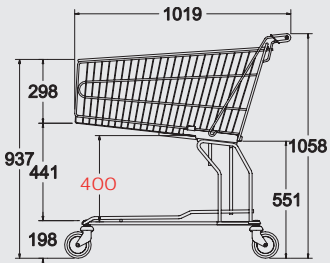

RUEDAS  
ROLLEN



3



6



7



8

PORTA-BEBE  
KINDERSITZ

SIN  
OHNE



CON  
MIT



CASGCS1503  
25,65 kg.

CASGCS1506  
25,85 kg.

CASGCS1507  
26,25 kg.

CASGCS1508  
25,65 kg.

CASGCP1503  
27,15 kg.

CASGCP1506  
27,35 kg.

CASGCP1507  
27,75 kg.

CASGCP1508  
27,15 kg.

PORTA-BEBE  
KINDERSITZ

SIN  
OHNE



CON  
MIT



CASSP16003  
22,75 kg.

CASSP16006  
22,95 kg.

CASSP16007  
23,35 kg.

CASSP16008  
22,75 kg.

CASCP16003  
24,25 kg.

CASCP16006  
24,45 kg.

CASCP16007  
24,85 kg.

CASCP16008  
24,25 kg.

150

160

# 180 L.



# 210 L.

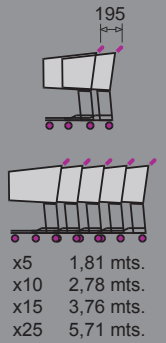
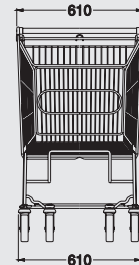
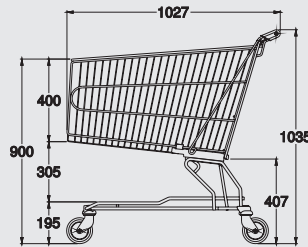
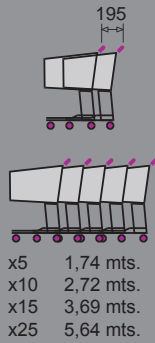
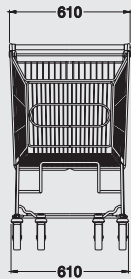
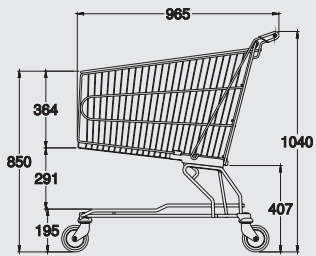

## RUEDAS ROLLEN



# 180

PORTA-BEBE  
KINDERSITZ

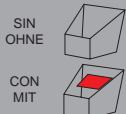

CASSP18003 24 kg.	CASSP18006 24,2 kg.	CASSP18007 24,6 kg.	CASSP18008 24 kg.
CASCP18003 25,5 kg.	CASCP18006 25,7 kg.	CASCP18007 26,1 kg.	CASCP18008 25,5 kg.

# 210

PORTA-BEBE  
KINDERSITZ

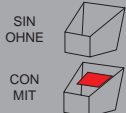

CASSP21003 25,3 kg.	CASSP21006 25,3 kg.	CASSP21007 25,8 kg.	CASSP21008 25,3 kg.
CASCP21003 26,8 kg.	CASCP21006 26,8 kg.	CASCP21007 27,3 kg.	CASCP21008 26,8 kg.



# 212 L.



# 240 L.

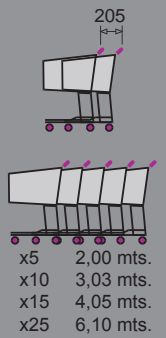
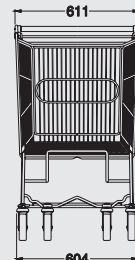
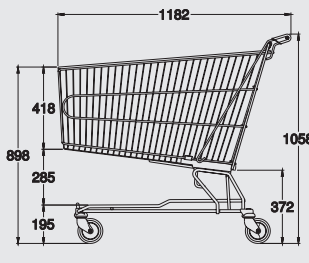
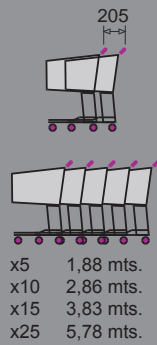
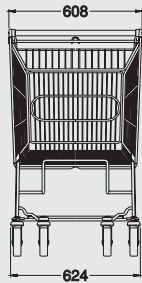
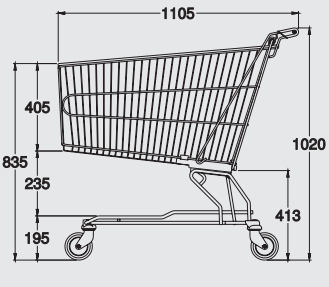

## RUEDAS ROLLEN



PORTA-BEBE  
KINDERSITZ

SIN  
OHNE



CON  
MIT



CASSP21203  
24,6 kg.

CASSP21206  
24,8 kg.

CASSP21207  
25,2 kg.

CASSP21208  
24,6 kg.

CASCP21203  
26,1 kg.

CASCP21206  
26,3 kg.

CASCP21207  
26,7 kg.

CASCP21208  
26,1 kg.

PORTA-BEBE  
KINDERSITZ

SIN  
OHNE



CON  
MIT



CASSP24003  
27,3 kg.

CASSP24006  
27,5 kg.

CASSP24007  
27,9 kg.

CASSP24008  
27,3 kg.

CASCP24003  
28,8 kg.

CASCP24006  
29 kg.

CASCP24007  
29,4 kg.

CASCP24008  
28,8 kg.

# 212

# 240



80 L.



100 L.

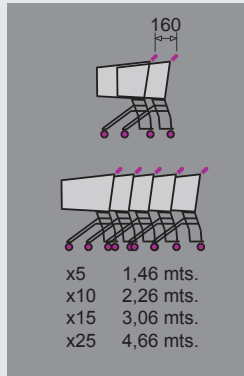
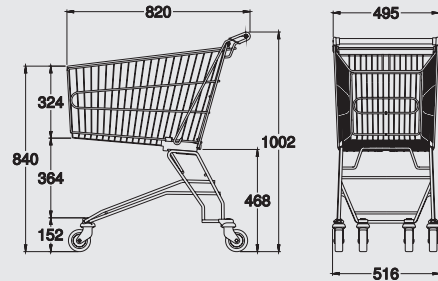
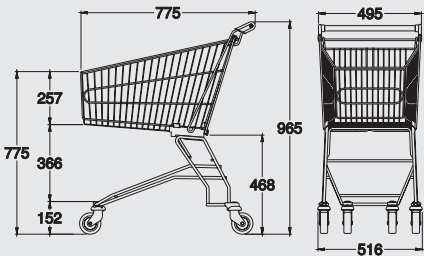

R U E D A S  
R O L L E N



80

PORTA-BEBE  
KINDERSITZ  
SIN OHNE  
CON MIT

CAASP08001 13,60 kg.	CAASP08002 14,50 kg.
CAACP08001 16,90 kg.	CAACP08002 16 kg.

100

PORTA-BEBE  
KINDERSITZ  
SIN OHNE  
CON MIT

	CAASP10002 15,55 kg.
	CAACP10002 17,05 kg.

# 120 L.



# 140 L.

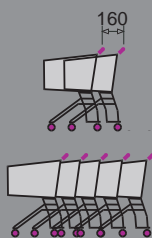
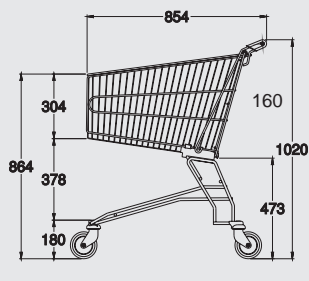

- x5 1,42 mts.
- x10 2,22 mts.
- x15 3,02 mts.
- x25 4,62 mts.

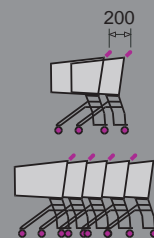

- x5 1,72 mts.
- x10 2,72 mts.
- x15 3,72 mts.
- x25 5,72 mts.

## RUEDAS ROLLEN



PORTA-BEBE  
KINDERSITZ

SIN  
OHNE



CON  
MIT



CAASP12003  
17,95 kg.

CAASP12006  
18,15 kg.

CAASP12007  
18,55 kg.

CAASP12008  
17,95 kg.

CAACP12003  
19,45 kg

CAACP12006  
19,65 kg.

CAACP12007  
20,05 kg.

CAACP12008  
19,45 kg.

PORTA-BEBE  
KINDERSITZ

SIN  
OHNE



CON  
MIT



CAASP14003  
22,10 kg.

CAASP14006  
22,3 kg.

CAASP14007  
22,7 kg.

CAASP14008  
22,10 kg.

CAACP14003  
23,60 kg.

CAACP14006  
23,8 kg.

CAACP14007  
24,2 kg.

CAACP14008  
23,60 kg.

# 140 120



# 150 L.

CARRO BASE DE CESTA ALTA  
KOMFORT EKW MIT HÖHEM KORBBODEN



# 160 L.

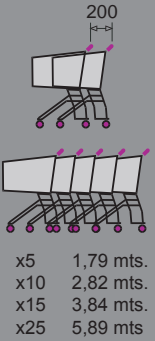
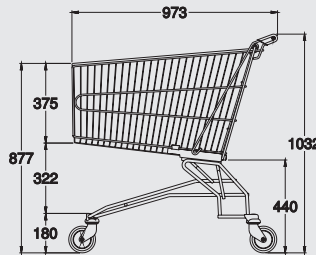
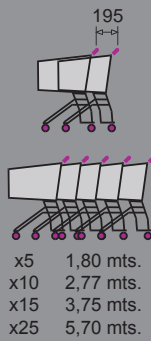
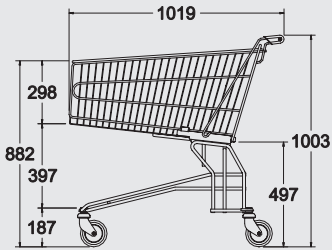

## RUEDAS ROLLEN



# 150

PORTA-BEBE  
KINDERSITZ

SIN  
OHNE



CON  
MIT



CAACES1503  
25,50 kg.

CAACES1506  
25,70 kg.

CAACES1507  
26,10 kg.

CAACES1508  
25,50 kg.

CASGCP1503  
27,15 kg.

CAACEP1506  
27,20 kg.

CAACEP1507  
27,6 kg.

CAACEP1508  
27,00 kg.

# 160

PORTA-BEBE  
KINDERSITZ

SIN  
OHNE



CON  
MIT



CAASP16003  
23,10 kg.

CAASP16006  
22,5 kg.

CAASP16007  
23,7 kg.

CAASP16008  
23,10 kg.

CAACP16003  
24,60 kg.

CAACP16006  
24,8 kg.

CAACP16007  
25,2 kg.

CAACP16008  
24,60 kg.



180 L.



210 L.

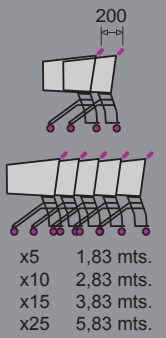
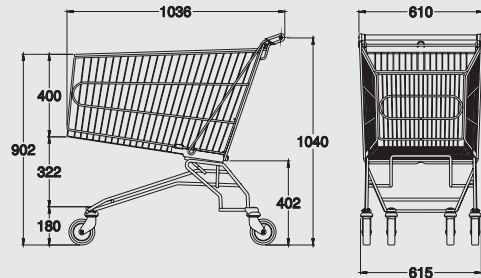
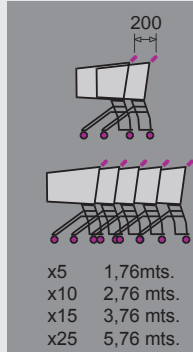
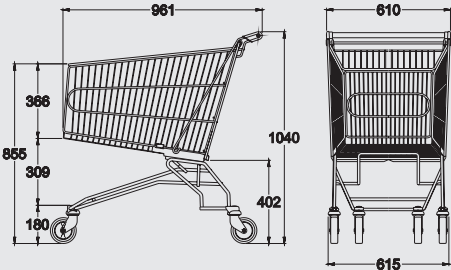

R U E D A S  
R O L L E N



PORTA-BEBE  
KINDERSITZ

SIN  
OHNE



CON  
MIT



CAASP18003  
23,6 kg.

CAASP18006  
23,8 kg.

CAASP18007  
24,2 kg.

CAASP18008  
23,6 kg.

CAACP18003  
25.10 kg.

CAACP18006  
25,3 kg.

CAACP18007  
25,7 kg.

CAACP18008  
25.10 kg.

PORTA-BEBE  
KINDERSITZ

SIN  
OHNE



CON  
MIT



CAASP21003  
24,70 kg.

CAASP21006  
24,9 kg.

CAASP21007  
25,3 kg.

CAASP21008  
24,70 kg.

CAACP21003  
26.20 kg.

CAACP21006  
26,4 kg.

CAACP21007  
26,8 kg.

CAACP21008  
26.20 kg.

210 180



# 212 L.



# 240 L.

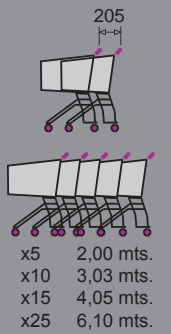
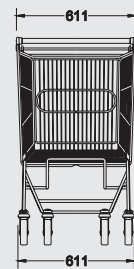
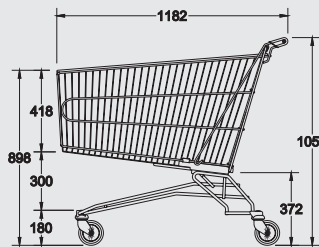
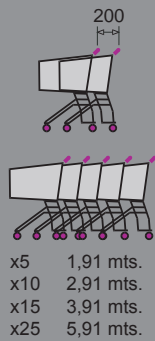
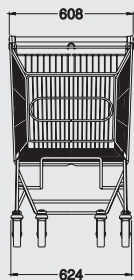
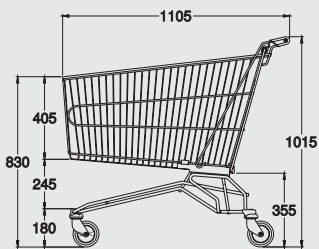

## RUEDAS ROLLEN



# 212

PORTA-BEBE  
KINDERSITZ

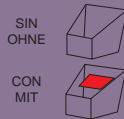

CAASP21203 25,05 kg.	CAASP21206 25,25 kg.	CAASP21207 25,65 kg.	CAASP21208 25,05 kg.
CAACP21203 26,55 kg.	CAACP21206 26,75 kg.	CAACP21207 27,15 kg.	CAACP21208 26,55 kg.

# 240

PORTA-BEBE  
KINDERSITZ

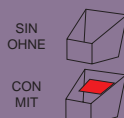

CAASP24003 27,75 kg.	CAASP24006 27,95 kg.	CAASP24007 28,35 kg.	CAASP24008 27,75 kg.
CAACP24003 29,25 kg.	CAACP24006 29,45 kg.	CAACP24007 29,85 kg.	CAACP24008 29,25 kg.

80 L.

CARRO DE COMPRA LIGERA  
EINKAUFSWAGEN LIGHT



100 L.

CARRO DE COMPRA LIGERA  
EINKAUFSWAGEN LIGHT

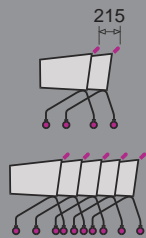
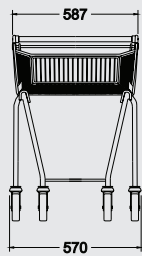
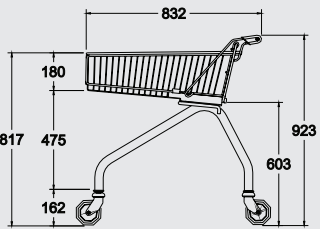

- x5 1,69 mts.
- x10 2,77 mts.
- x15 3,84 mts.
- x25 5,99 mts.

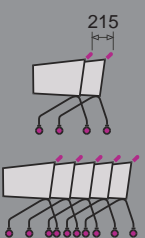
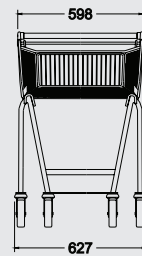
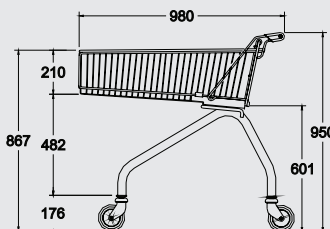

- x5 1,83 mts.
- x10 2,91 mts.
- x15 3,98 mts.
- x25 6,13 mts.

RUEDAS  
ROLLEN



80

CCLSP08003  
18,70 kg.

CCLSP08006  
18,80 kg.

CCLSP08007  
19,20 kg.

CCLSP08008  
18,70 kg.

100

CCLSP10003  
18,45 kg.

CCLSP10006  
18,65 kg.

CCLSP10007  
19,05 kg.

CCLSP10008  
18,45 kg.



200 L.

CARRO FRONTAL ABATIBILE  
EINKAUFSWAGEN MIT FRONTKLAPPE



212 L.

CARRO " T-M "

EINKAUFSWAGEN " T-M "

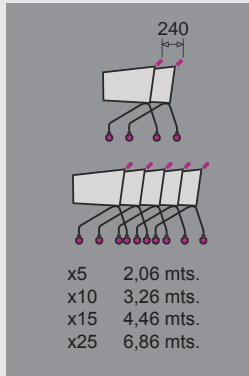
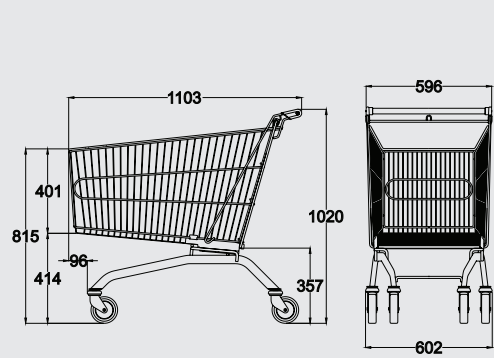
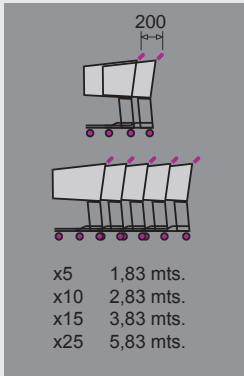
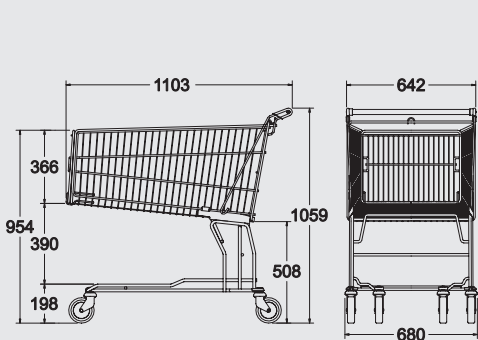

R U E D A S  
R O L L E N



3



6



7



8

200

PORTA-BEBE  
KINDERSITZ

SIN  
OHNE

CON  
MIT



CASSPAF203  
29,3 kg.

CASSPAF206  
29,3 kg.

CASSPAF207  
29,8 kg.

CASSPAF208  
29,1 kg.

CASCPAF203  
30,8 kg.

CASCPAF206  
30,8 kg.

CASCPAF207  
31,3 kg.

CASCPAF208  
30,6 kg.

212

PORTA-BEBE  
KINDERSITZ

SIN  
OHNE

CON  
MIT



CAALSP21203  
21,70 kg.

CAALSP21206  
21,50 kg.

CAALSP21207  
22,30 kg.

CAALSP21208  
21,70 kg.

CAALCP21203  
23,20 kg.

CAALCP21206  
23,00 kg.

CAALCP21207  
23,80 kg.

CAALCP21208  
23,20 kg.

# 120 L.

CARRO SKALATOR  
SKALATOR EINKAUFSWAGEN



# 140 L.

CARRO SKALATOR  
SKALATOR EINKAUFSWAGEN

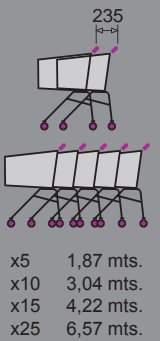
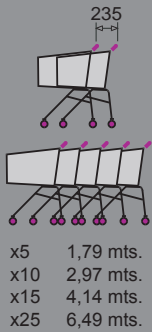
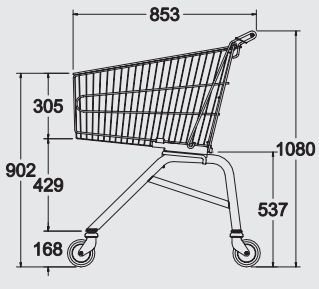

## RUEDAS ROLLEN



PORTA-BEBE  
KINDERSITZ

SIN  
OHNE  
CON  
MIT



CAK0012003  
18,45 kg.

CAK0012006  
18,25 kg.

CAK0012007  
19,05 kg.

CAK0012008  
18,45 kg.

CAPK012003  
19,95 kg.

CAPK012006  
19,75 kg.

CAPK012007  
20,55 kg.

CAPK012008  
19,95 kg.

PORTA-BEBE  
KINDERSITZ

SIN  
OHNE  
CON  
MIT



CAK0014003  
19,65 kg.

CAK0014006  
19,45 kg.

CAK0014007  
20,25 kg.

CAK0014008  
19,65 kg.

CAPK014003  
21,15 kg.

CAPK014006  
20,95 kg.

CAPK014007  
21,75 kg.

CAPK014008  
21,15 kg.

# 120

# 140



140 L.

CARRO " E-M "  
EINKAUFWAGEN " E-M "



62 L.

CARRO ESPECIAL PARA SILLAS DE RUEDAS 62L  
SPEZIELLER WAGEN FÜR ROLLSTÜHLE 62L

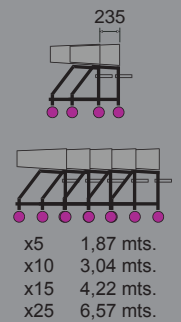
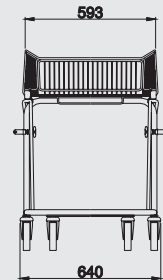
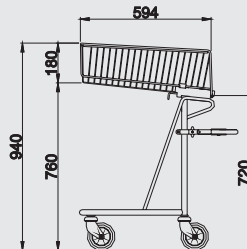
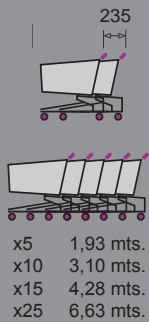
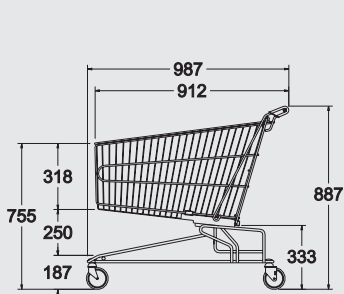

R U E D A S  
R O L L E N



140

CAEM1406-7  
26,0 kg.

CAEM1407-8  
26,0 kg.

62

CAMV6203  
14,45 kg.

CAMV6206  
14,65 kg.

CAMV6207  
15,05 kg.

CAMV6208  
14,45 kg.

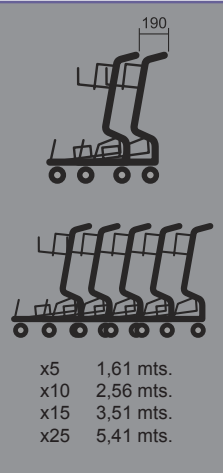

PEQUEÑO  
KLEIN

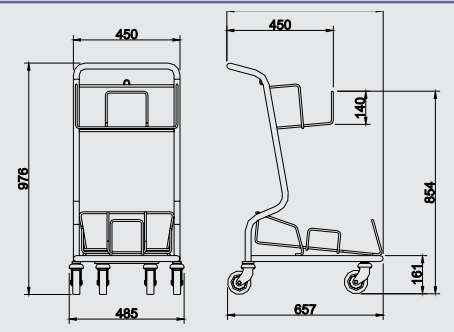

CMCP02

CMCP02-2F



CARRO MULTICESTA

MERHKORB EINKAUFSWAGEN

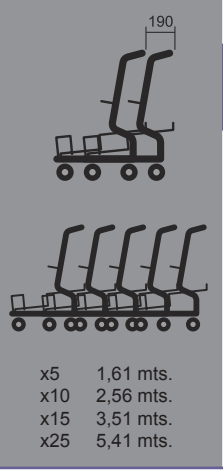

GRANDE  
GROß

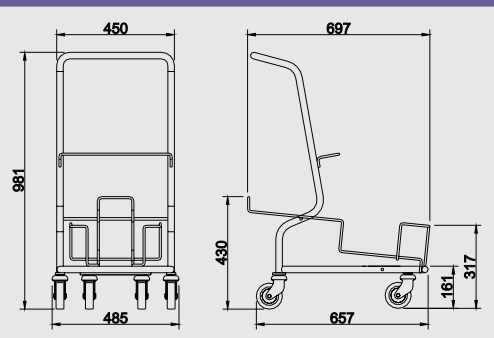

CMCG02

CMCG02-2F

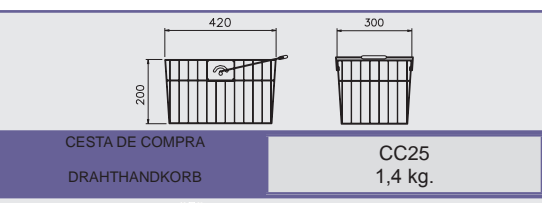
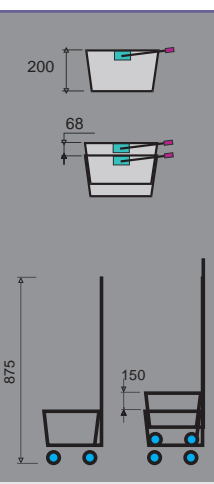
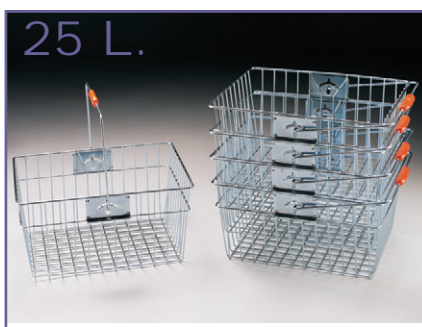

CESTA DE COMPRA  
DRAHTHANDKORB

CC25  
1,4 kg.

CESTAS DE COMPRA

DRAHTHANDKÖRBE

CARRO PARA CESTA DE COMPRA  
WAGEN FÜR DRAHTHANDKORB

CPCC25  
6,0 Kg.

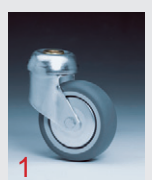
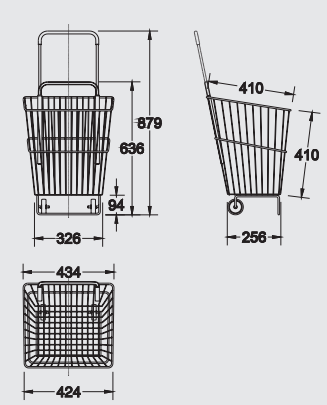
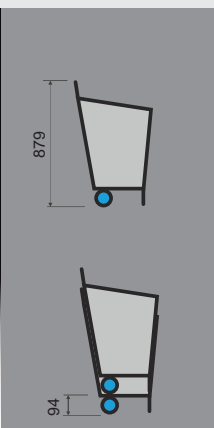

CC5001  
1,4 Kg.



STD



REJILLA PLATAFORMA  
DRAHTPLATTFORM

RPCA80 RPCA100 RPCA120  
RPCA140 RPCA150 RPCA160  
RPCA180 RPCA210 RPCA212  
RPCA240



CONJUNTO PROTECCION CESTO  
KORBSCUTZPROFIL

CPC50 CPC60 CPC80  
CPC100 CPC120 CPC140  
CPC150 CPC160 CPC180  
CPC210 CPC212 CPC240



CANTONERAS  
KORBSCUTZECKEN

CPEC



SEPARADOR GESTA PEQUEÑO  
DRAHTSCHALE

SPCA180 SPCA210 SPCA212  
SPCA240



SEPARADOR CESTA  
QUERTRENNGITTER

SCA120 SCA140 SCA150  
SCA160 SCA180 SCA210  
SCA212 SCA240



DOBLE PORTA-BEBE  
ZWILLING KINDERSITZ

DPBI



PORTA-BEBE DOBLE FUNCION  
KINDERSITZ - WARENABLAG

PBPDFI



RACK BOTELLERO FIJO  
STARRE KISTENABLAG

RBF240



RACK BOTELLERO PLEGABLE  
AUSGEKLAPPT KISTENABLAG

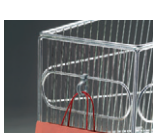

GANCHO CUELGA-BOLSOS  
TASCHENHAKEN

GBCBA

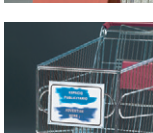

PORTACARTEL PUBLICITARIO  
PLAKATRAHMEN

PCPCA80160  
PCPCA180240



CUNA DE CESTO  
BABYSCHALE

CCBD



SOPORTE PARA CUNA  
BABY SCHALENKORB

CSCM

	50	60	80	100	120	140	150	160	180	210	212	240
REJILLA PLATAFORMA DRAHTPLATTFORM			●	●	●	●	●	●	●	●	●	●
CONJUNTO PROTECCION CESTO KORBSCUTZPROFIL	●	●	●	●	●	●	●	●	●	●	●	●
CANTONERAS KORBSCUTZECKEN	●	●	●	●	●	●	●	●	●	●	●	●
SEPARADOR GESTA PEQUEÑO DRAHTSCHALE									●	●		
SEPARADOR CESTA QUERTRENNGITTER					●	●	●	●	●	●	●	●
DOBLE PORTA-BEBE ZWILLING KINDERSITZ									●	●	●	●
PORTA-BEBE DOBLE FUNCION KINDERSITZ - WARENABLAG						●	●	●	●	●	●	●
RACK BOTELLERO FIJO STARRE KISTENABLAG												●
RACK BOTELLERO PLEGABLE AUSGEKLAPPT KISTENABLAG												
GANCHO CUELGA-BOLSOS TASCHENHAKEN	●	●	●	●	●	●	●	●	●	●	●	●
PORTACARTEL PUBLICITARIO PLAKATRAHMEN			●	●	●	●	●	●	●	●	●	●
CUNA DE CESTO BABYSCHALE						●	●	●	●	●	●	●
SOPORTE PARA CUNA BABY SCHALENKORB									●	●	●	●



80	100	120	140	150	160	180	210	212	240
●	●	●	●	●	●	●	●	●	●
●	●	●	●	●	●	●	●	●	●
						●	●		
		●	●	●	●	●	●	●	●
						●	●	●	●
			●	●	●	●	●	●	●
●	●	●	●	●	●	●	●	●	●
●	●	●	●	●	●	●	●	●	●
			●	●	●	●	●	●	●
						●	●	●	●

REJILLA PLATAFORMA  
DRAHTPLATTFORM



CONJUNTO PROTECCION CESTO  
KORBSCHTZPROFIL  
CPC50 CPC60 CPC80  
CPC100 CPC120 CPC140  
CPC150 CPC160 CPC180  
CPC210 CPC212 CPC240



CANTONERAS  
KORBSCHTZZECKEN  
CPEC



SEPARADOR CESTA PEQUEÑO  
DRAHTSCHALE  
SPCA140 SPCA150 SPCA160  
SPCA180 SPCA210 SPCA212  
SPCA240



SEPARADOR CESTA  
QUERTRENNGITTER  
SCA140 SCA150 SCA160  
SCA180 SCA210 SCA212  
SCA240



DOBLE PORTA-BEBE  
ZWILLING KINDERSITZ  
DPBI



PORTA-BEBE DOBLE FUNCION  
KINDERSITZ - WARENABLAGE  
PBPDFI



RACK BOTELLERO FIJO  
STARRE KISTENABLAGE  
RBF1821  
RBF1416



RACK BOTELLERO PLEGABLE  
AUSGEKLAHPTE KISTENABLAGE  
RB1821



GANCHO CUELGA-BOLSOS  
TASCHENHAKEN  
GCBCA

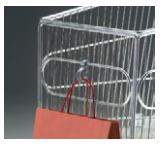

PORTACARTEL PUBLICITARIO  
PLAKATRAHMEN  
PCPCA80160  
PCPCA180240



CUNA DE CESTO  
BABYSCHALE  
CCBD



SOPORTE PARA CUNA  
BABY SCHALENKORB  
CSCM



SPC



	80 COMPRA LIGERA EINKAUFSWAGEN LIGHT	100 COMPRA LIGERA EINKAUFSWAGEN LIGHT	200 FRONTALABATIBLE EINKAUFSWAGEN MITFRONTKLAPPE	212 CARRO "T-M" EINKAUFSWAGEN "T-M"	120 SKALATOR	140 SKALATOR	140 CARRO "E-M" EINKAUFSWAGEN "E-M"	62 MINUSVALIDO EKW FÜR ROLLSTUHLFAHRER
REJILLA PLATAFORMA DRAHTPLATTFORM RPCA140 (200) RPCA212			●	●				
CONJUNTO PROTECCION CESTO KORBSCHTZPROFIL CPC80 CPC100 CPC120 CPC140 CPC212	●	●		●	●	●	●	
CANTONERAS KORBSCHTZZECKEN CPEC	●	●		●	●	●	●	
SEPARADOR CESTA PEQUEÑO DRAHTSCHALE								
SEPARADOR CESTA QUERTRENNGITTER SCA140 SCA212				●		●	●	
DOBLE PORTA-BEBE ZWILLING KINDERSITZ DPBI				●				
PORTA-BEBE DOBLE FUNCION KINDERSITZ - WARENABLAGE PBPDFI			●	●				
RACK BOTELLERO FIJO STARRE KISTENABLAGE RBF8010	●	●						
RACK BOTELLERO PLEGABLE AUSGEKLAPPTE KISTENABLAGE RB212				●				
GANCHO CUELGA-BOLSOS TASCHENHAKEN GBCBA	●	●		●	●	●	●	
PORTACARTEL PUBLICITARIO PLAKATRAHMEN PCPCA80160 PCPCA180240				●	●	●	●	
CUNA DE CESTO BABYSCHALE CCBD				●				
SOPORTE PARA CUNA BABY SCHALENKORB CSCM				●				





El parking es el primer contacto visual de su negocio con su cliente y exponente principal de su marca.

Unos cobijos personalizados refuerzan el impacto de imagen de su tienda con respecto a su entorno. Consúltenos para realizaciones a su medida.

Die Parkboxen sind den ersten Sichtkontakt der Kunden mit Ihrem Geschäft, und verstärken das Image der Läden. Personalisierte Parkboxen (maßgerecht), wo Ihre Einkaufswagen geordnet und geschützt sind.





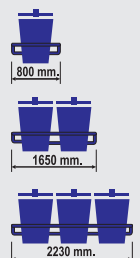
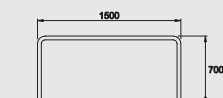
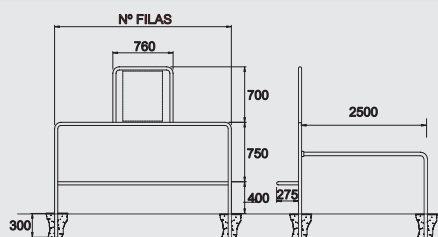
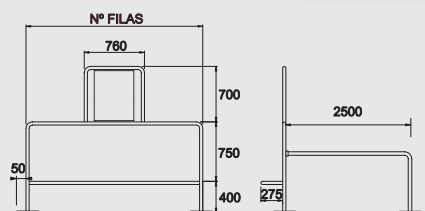
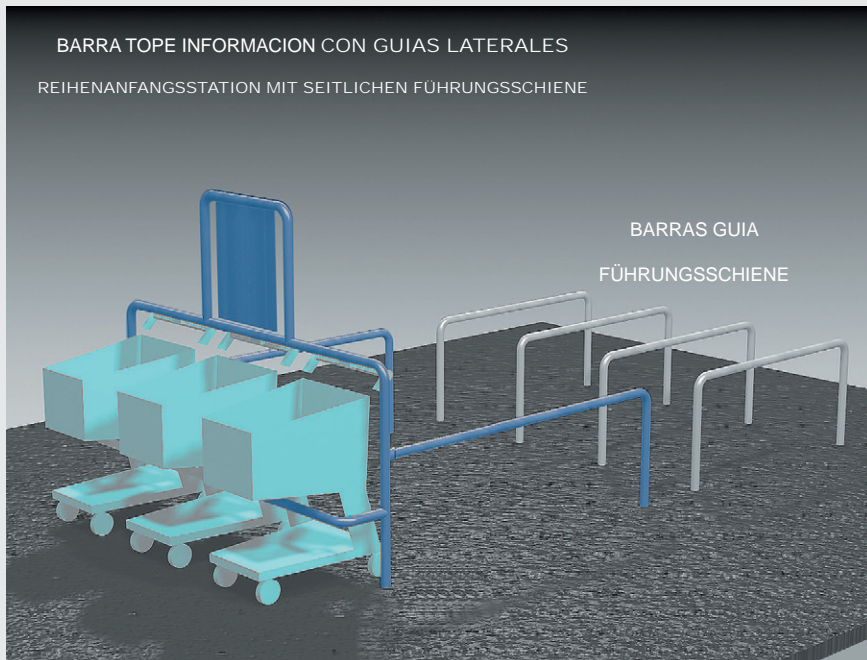
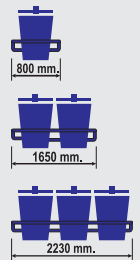
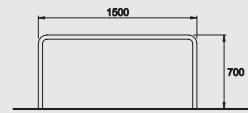
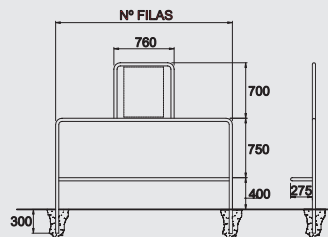
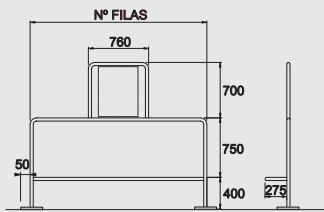
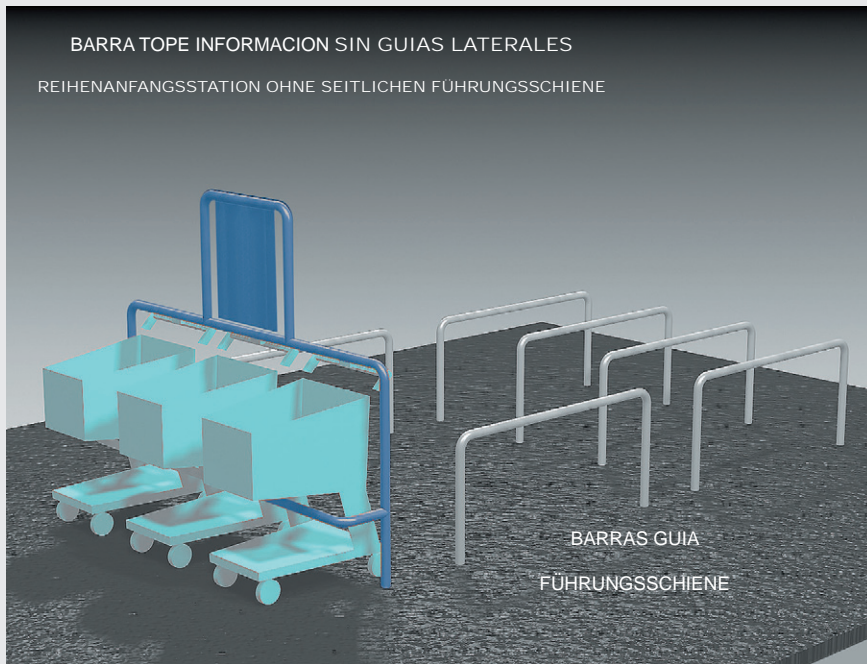



**AENOR** Asociación Española de  
Normalización y Certificación

**CERTIFICADO AENOR DE PRODUCTO N° A12 / 000001**  
AENOR PRODUCT CERTIFICATE N°

Pg. 1/13  
2014-02-03

La Asociación Española de Normalización y Certificación (AENOR) certifica que el producto  
The Spanish Association for Standardisation and Certification (AENOR) certifies that the product

**CARROS DE COMPRA METÁLICOS PARA USUARIOS DE SUPERMERCADO E  
HIPERMERCADO**

**METALLIC BASKET TROLLEYS FOR SUPERMARKET USERS**

detallado en la(s) página(s) siguiente(s), detailed in the following page(s),  
suministrado por supplied by

**CREACIONES MARSANZ, S.A.**  
**CL HIERRO, 27**  
**28850 TORREJON DE ARDOZ (Madrid - ESPAÑA)**

y elaborado en and manufactured in

**CL HIERRO, 27**  
**28850 TORREJON DE ARDOZ (Madrid - ESPAÑA)**

es conforme con complies with

**UNE-EN 1929-1:1998 (EN 1929-1:1998)**  
**UNE-EN 1929-2:2005 (EN 1929-2:2004)**  
**UNE-EN 1929-3:2005 (EN 1929-3:2005)**  
**UNE-EN 1929-4:2005 (EN 1929-4:2005)**  
**UNE-EN 1929-7:2005 (EN 1929-7:2005)**

Para conceder este Certificado, AENOR ha ensayado el producto y ha comprobado el sistema de la calidad aplicado para su elaboración. AENOR realiza estas actividades periódicamente mientras el Certificado no haya sido anulado, según se establece en el Reglamento Particular RP A12.01.

In order to grant this Certificate, AENOR has tested the product and has verified the quality system used in its manufacture. AENOR performs these tasks periodically while the Certificate has not been cancelled, in accordance with the stipulations of the Specific Rules RP A12.01.

Fecha de concesión: **2004-02-03**  
First issued on:

Fecha de renovación: **2014-02-03**  
Renewed on:

Fecha de caducidad: **2019-02-03**  
Expires on:

**AENOR** Asociación Española de  
Normalización y Certificación

Avelino BRITO MARQUINA  
Director General de AENOR/ Chief Executive Officer

No está autorizada la reproducción parcial de este documento.

The partial reproduction of this document is not permitted.

AENOR - Génova, 6 - 28004 MADRID - Teléfono 914 32 60 00 - Telefax 913 10 46 83



www.marsanz.es



SEDE SOCIAL

HAUPTSITZ

CALLE HIERRO, 27  
28850 TORREJON DE ARDOZ  
MADRID  
ESPAÑA - SPAIN

TEL.: (34) 91 675 14 34 // (34) 91 677 10 92  
FAX.: (34) 91 675 12 90  
E.MAIL.: creaciones@marsanz.es

PLANTAS DE FABRICACION  
PRODUKTIONSANLAGEN

TORREJON DE ARDOZ (MADRID)  
UGENA (TOLEDO)

INTERNACIONAL  
INTERNATIONAL

EXPORT ABTEILUNG

E.MAIL.: export@marsanz.es

www.marsanz.es

FRANCIA  
FRANKREICH

MARSANZ FRANCE SAS

13 RUE SAINT HONORÉ  
78000 VERSAILLES

TEL.: +33 (0) 1 30 88 82 95  
E.MAIL.: info@marsanz.fr  
www.marsanz.fr

REINO UNIDO  
VEREINIGTE KÖNIGREICH

MARSANZ UK Ltd.

28 ST CLEMENTS ROAD  
MANCHESTER, M21 9HU

TEL.: +44 (0) 1618818515  
E.MAIL.: info@marsanz.co.uk  
www.marsanz.co.uk

DELEGACIONES EN ESPAÑA

SPANISCHE FILIALEN

BARCELONA

POLIGONO INDUSTRIAL MOLI D'EN XECH  
Calle Barneda, Nº 17 nave 25  
Frente Rio Ripoll  
08291 - RIPOLLET

TEL.: 93 231 34 75  
FAX.: 93 231 35 47  
E.MAIL.: barcelona@marsanz.es

SEVILLA

AVDA. DEL PARSÍ  
POL.IND. MINI PARSÍ, NAVE 9  
41016 SEVILLA

TEL.: 95 451 12 45  
FAX.: 95 425 85 09  
E.MAIL.: andalucia@marsanz.es

ALICANTE

C/ CAMPELLO, 13  
POL.IND. LA CALA  
03509 FINESTRAT - ALICANTE

TEL.: 96 680 27 04  
FAX.: 96 683 07 96  
E.MAIL.: levante@marsanz.es

DISTRIBUIDO POR

VERTRIEBEN VON

ES

DE

*La Marsanz*



[www.marsanz.es](http://www.marsanz.es)

1