

Hybrids

Hybrides



Shopping trolleys
Chariots libre-service

EN FR

Le Marsanz

6

SUMMARY

SOMMAIRE

CERTIFICATES - CERTIFICATS	2 - 3
TECHNICAL SPECIFICATIONS - SPECIFICATIONS TECHNIQUES	4 - 5
ACCESSORIES AND MISCELLANEOUS - ACCESSOIRES ET COMPLEMENTES	6-7
POLYSTEEL STANDARD LINE - POLYSTEEL GAMME STANDARD	
242 L STD	8
220 L STD - 195 L STD	9
160 L STD - 140 L STD (FOR CRATES - GRANDE CHARGE)	10
160 L STD - 140 L STD	11
110 L STD - 90 L STD	12
ACCESSORIES STD - ACCESSOIRES GAMME STANDARD	13
POLYSTEEL ANTI-THEFT LINE - POLYSTEEL GAMME SECURITE	
242 L ATH	14
220 L ATH - 195 L ATH	15
160 L ATH - 140 L ATH	16
110 L ATH - 90 L ATH	17
ACCESSORIES ATH - ACCESSOIRES GAMME SECURITE	18
POLYSTEEL BGA LINE - POLYSTEEL GAMME BGA	
110 L TECHNO-GARDEN - CHARIOT JARDINERIE	19
110 L TECHNO-DIY - TECHNO-BRICOLAGE	19
90 L TECHNO-GARDEN - CHARIOT JARDINERIE	20
90 L HEAVY DUTY TECHNO DIY - CHARIOT JARDINERIE GRANDE CHARGE	20
90 L TECHNO-DIY - TECHNO-BRICOLAGE	21
90 L HEAVY DUTY TECHNO DIY -TECHNO-BRICOLAGE GRANDE CHARGE	21
ACCESSORIES BGA - ACCESSOIRES GAMME BGA	22
MULTIGRIP	
150 L STD FOR CRATES - STD GRANDE CHARGE	23
150 L STD - 130 L STD	24
150 L ATH - 130 L ATH	25
100 L ATH	26
98 L ATH - 80 L ATH	27
MULTIGRIP ACCESSORIES - ACCESSOIRES MULTIGRIP	28
TROLLEY SHELTER - ABRIS CHARIOTS	29
TROLLEY BAY - AIRES DE STOCKAGE	30

CREACIONES MARSANZ, s.a. reserves the right to change any product from this catalogue without prior notice. Partial or full duplication of this catalogue is also prohibited.

CREACIONES MARSANZ, s.a. se réserve le droit de modifier, sans préavis, tous les produits présentés dans ce catalogue. De même, la reproduction totale ou partielle est interdite sans autorisation.

POLYSTEEL

AENOR

AENOR Product Certificate Basket trolleys



A12/000003

AENOR certifies that the organization

CREACIONES MARSANZ, S.A.

registered office CL HIERRO, 27 - 28850 TORREJON DE ARDOZ (Madrid - España)

supplies Plastic basket trolleys for supermarket users

in compliance with UNE-EN ISO 4892-2:2006/A1:2010 (EN ISO 4892-2:2006/A1:2009)
 UNE-EN 1929-1:1998 (EN 1929-1:1998)
 UNE-EN 1929-2:2005 (EN 1929-2:2004)
 UNE-EN 1929-3:2005 (EN 1929-3:2005)
 UNE-EN 1929-4:2005 (EN 1929-4:2005)
 UNE-EN 1929-7:2005 (EN 1929-7:2005)

References Specified in Annex to the Certificate

Production site CL HIERRO, 27 28850 TORREJON DE ARDOZ (Madrid - España)

Certification scheme In order to grant this Certificate, AENOR has tested the product and has verified the quality system implemented for its manufacture. AENOR performs these tasks periodically while the Certificate has not been cancelled, in accordance with Specific Rules RP A12.01.

First issued on 2013-12-11
 Last issued on 2018-12-11
 Validity date 2023-12-11

Rafael GARCÍA MEIRO
Chief Executive Officer

Original Electronic Certificate

AENOR INTERNACIONAL S.A.U.
 Génova, 6. 28004 Madrid. España
 Tel. 91 432 60 00.- www.aenor.com

AENOR

AENOR Product Certificate Basket trolleys



A12/000006

AENOR certifies that the organization

CREACIONES MARSANZ, S.A.

registered office CL HIERRO, 27 - 28850 TORREJON DE ARDOZ (Madrid - España)

supplies Plastic basket trolleys for supermarket users

in compliance with UNE-EN ISO 4892-2:2006/A1:2010 (EN ISO 4892-2:2006/A1:2009)
 UNE-EN 1929-1:1998 (EN 1929-1:1998)
 UNE-EN 1929-2:2005 (EN 1929-2:2004)
 UNE-EN 1929-3:2005 (EN 1929-3:2005)
 UNE-EN 1929-4:2005 (EN 1929-4:2005)

References Specified in Annex to the Certificate

Production site CL HIERRO, 27 28850 TORREJON DE ARDOZ (Madrid - España)

Certification scheme In order to grant this Certificate, AENOR has tested the product and has verified the quality system implemented for its manufacture. AENOR performs these tasks periodically while the Certificate has not been cancelled, in accordance with Specific Rules RP A12.01.

First issued on 2017-03-16
 Validity date 2022-03-16

Avelino BRITO
General Manager

Original Electrónico

AENOR INTERNACIONAL S.A.U.
 Génova, 6. 28004 Madrid. España
 Tel. 91 432 60 00.- www.aenor.com

CHARACTERISTICS

POLYSTEEL AND MULTIGRIP TROLLEYS: The trolleys are composed of a polymeric polypropylene basket and a metal tube platform. The platform have different kind of wheels to adapt the trolleys to its surface. The handle is available both in metal tube as in thermoplastic polymeric material.

TROLLEYS MADE ACCORDING TO REQUIREMENTS OF THE UNE IN 1929-1 / UNE IN 1929-2 / UNE IN 1929-3 / UNE IN 1929-4 / UNE IN 1929-7

MATERIALS

HANDLES

Metal handles: tube handle of 25x1,5mm thick diametre made of high quality electro-galvanized steel, with embossing at the endcaps to prevent its rotation, covered with plasticized paper for personalized silkscreening and with a transparent PVC sheath for greater UV protection .

Thermoplastic polymeric handles:

Ergobox handle: made in polymeric material ASA/PC (Styrene-acrylonitrile/polycarbonate) which provides high rigidity and resistance to impact. It has good resistance to ultraviolet radiation, weather and heat.

Ergogrip handle: made in PVC.

BASKET AND BACK FLAP

Basket and back flap trolley for POLYSTEEL / MULTIGRIP line: made of injected polypropylene polymeric material with protection against UV radiation; resistant to acids, detergents and saline solutions, without electromagnetic incompatibility. Excellent degree of structural grid transparency.

PLATFORM

Polysteel/Multigrip trolley: steel metal platform made of high quality in accordance to the standards of the UNE EN 16120 Part 2/ UNE EN 10305. They are composed of 11,8 and 13,5mm diametre rods, by 40 x 20 mm oval tubes and by wheel anchor plates with thicknesses of 8mm. Welded joints with average penetrations of 15% for the rods, and therefore in the rest of the joints.

COATING

Zinc coated: electrolytic zinc treatment applied in a layer from 10 to 205 microns thick.

Transparent polyester with electrostatic powder application from 90 to 100 microns and polymerized at 200°C

ERGONOMICS, COMFORT AND RFID TECHNOLOGIES

All trolleys in accordance with all confort and ergonomic requirements within Standards

UNE-EN 1929-1 / UNE-EN 1929-2 / UNE-EN 1929-3 / UNE-EN 1929-4 / UNE-EN 1929-7.

Trolley adapted for identification and automatic billing through the electronic labeling system.

Compatible with RFID (radio frequency identification).

*Pending of certification.



CARACTERISTIQUES

CHARIOTS GAMME POLYSTEEL / MULTIGRIP: Composés d'un panier en polymère de polypropylène et d'un socle de tube métallique. Les socles ont différents types de roues afin adapter les chariots aux surfaces utilisées. La poignée du chariot est disponible en métal ou en polymère thermoplastique.

**CHARIOTS FABRIQUES SELON LES EXIGENCES DE LA NORME :
UNE EN 1929-1 / UNE EN 1929-2 / UNE EN 1929-3 / UNE EN 1929-4 / UNE EN 1929-7**

MATERIAUX

POIGNEES

Poignées métalliques : poignée tubulaire de diamètre 25 x 1,5 mm d'épaisseur en acier électrozingué de première qualité, avec extrémités embouties pour éviter la rotation, recouverte de papier plastifié pour la sérigraphie personnalisée ainsi que d'une housse en PVC transparent pour une meilleure protection contre les UV.

Poignées en polymère thermoplastique:

Poignée ERGOBOX : en polymère ASA/PC (Acrylonitrile Styrene/Polycarbonate) qui offre une grande résistance aux chocs ainsi qu'une grande rigidité. Poignée ayant une résistance importante aux rayons ultraviolets, aux intempéries et à la chaleur.

Poignée ERGOGRIP: fabriquée en PVC.

PANIER ET BATTANT

Panier et battant de la série POLYSTEEL / MULTIGRIP : fabriqués en polymère de Polypropylène injecté avec protection contre les rayons UV ; résistants aux acides, aux détergents et aux solutions salines, sans incompatibilité électromagnétique. Excellent degré de transparence de la grille structurelle.

SOCLE

Chariot de la série POLYSTEEL / MULTIGRIP : socle en acier fabriqué avec des matériaux de première qualité selon les normes UNE EN 16120 Partie 2 / UNE EN 10305, composé de barres de 11,8 et 13,5 mm de diamètre, de tubes ovales de 40 x 20 x 2 et de plaques d'ancrage pour roues ayant une épaisseur de 8 mm.

Pour les tiges, joints soudés avec des pénétrations moyennes de 15%, pour le reste apport de soudures au niveau des joints.

REVETEMENTS

Zingage : Traitement de zinc électrolytique avec un revêtement de 10 à 25 microns.

Polyester transparent avec application électrostatique en poudre de 90 à 100 microns et polymérisé à 200 °C.

CONFORT, ERGONOMIE, SECURITE ET TECHNOLOGIE RFID

Répond à toutes les exigences de confort, d'ergonomie et de sécurité selon les normes UNE EN 1929-1 / UNE EN 1929-2 / UNE EN 1929 -3 / UNE EN 1929 -4 / UNE EN 1929 -7

Chariot permettant l'identification et la facturation automatique par le biais du système d'étiquetage électronique.

Compatible avec la RFID (Radio Frequency Identification).

*En attente de certification.

ALL THE WHEELS OF OUR PRODUCTS ARE APPROVED AND HOMOLOGATED BY THE C.E.N. N-1049 NORM.

TOUTES LES ROULETTES DE NOS PRODUITS SONT CONFORMEES ET HOMOLOGUEES SELON LA NORME C.E.N. N-1049.



2 - Ø100

Swivel castor, housing made of pressed steel, bright zinc plated, blue passivated, double ball bearing swivel head, wheel axle with nut, bolt hole. Wheel centre made of Polypropylene, Tread: solid rubber, grey non-marking, precision ball bearing

Technical Data :

Wheel diameter 100 mm - Width of Tread 32 mm - Centre hole 13 mm - Offset 35 mm,
Swivel Interference 170 mm - Overall height 129 mm - Temperature - 20 / + 60 °C - Standard EN 12530 - Weight 0.58 kg
Swivel Radius 85 mm - Hardness of tread A 75 - Load capacity 80 kg - Load capacity (static) 160kg .

Roulette pivotante, chape en acier embouti, finition zinguée, pivot sur double chemin de billes, axe de roue boulonné, trou central. Corps de roue polypropylène, bandage caoutchouc semi-élastique gris non tachant, roulement à billes de précision avec pare-fils

Fiche technique:

Diamètre de roue 100 mm - Largeur de bandage 32 mm - Trou central 13 mm - Déport 35 mm - Diamètre d'encombrement Ø 170 mm
Hauteur 129 mm, Résistance à la température - 20 / + 60 °C - Norme EN 12530 - Poids 0.58 kg - Rayon d'encombrement 85 mm,
Dureté du bandage shore A 75 - Capacité de charge dynamique 80 kg - Capacité de charge statique 160 kg .



3 - Ø125

Swivel castor, housing made of pressed steel, bright zinc plated, blue passivated, double ball bearing swivel head, wheel axle with nut, and bolt hole. Wheel centre made of Polypropylene, Tread: solid rubber, grey non-marking, precision ball bearing

Technical Data :

Wheel diameter 125 mm - Width of Tread 32 mm - Centre hole 13 mm - Offset 38 mm,
Swivel Interference 201 mm - Overall height 155 mm - Temperature - 20 / + 60 °C - Standard EN 12530 - Weight 0.777 kg
Swivel Radius 100.5 mm - Hardness of tread A 75 - Load capacity 80 kg - Load capacity (static) 160 kg .

Roulette pivotante, chape en acier embouti, finition zinguée, pivot sur double chemin de billes, axe de roue boulonné, trou central. Corps de roue polypropylène, bandage caoutchouc semi-élastique gris non tachant, roulement à billes de précision avec pare-fils

Fiche technique:

Diamètre de roue 125 mm - Largeur de bandage 32 mm - Trou central 13 mm - Déport 38 mm - Diamètre d'encombrement Ø 201 mm
Hauteur 155 mm, Résistance à la température - 20 / + 60 °C - Norme EN 12530 - Poids 0.77 kg - Rayon d'encombrement 100.5 mm,
Dureté du bandage shore A 75 - Capacité de charge dynamique 80 kg - Capacité de charge statique 160 kg .



8 - Ø125

Autowalk castor with integrated brake shoe for moving walkways, threadguards with integrated brake shoe, housing made of pressed steel, bright zinc plated, blue passivated, double ball bearing swivel head, wheel axle with nut, wheel centre made of Polyurethane, Tread: Polyurethane, 4 tracks, selfcleaning between tracks, with threadguards, precision ball bearing, distances between tracks: approx. 4.5 mm, track width: approx. 4.0 mm. Designed for the following pallet size: track width: approx. 2,75 mm, groove width: approx. 5,7 mm, groove depth: > 10 mm.

Hint:

Load capacity 80 kg per castor on level and securely attached floors, 40 kg per castor on walkways. Please note that according to EN1929 only castors with a minimum wheel diameter of 120 mm can be used on walkways.

Technical Data :

Wheel diameter 125 mm - Width of Tread 32 mm - Centre hole 13 mm - Offset 40 mm,
Swivel Interference 205 mm - Overall height 153 mm - Temperature - 40 / + 60 °C - Standard EN 12530 - Weight 0.731kg
Swivel Radius 102.5 mm - Hardness of tread Shore D 59 - Load capacity 80 kg - Load capacity (static) 160 kg .

Roulettes pour chariots libre service avec frein intégré pour tapis roulants, chape en acier embouti, finition zinguée, pivot sur double chemin de billes, axe de roue boulonné, corps de roue polyuréthane, bandage: polyuréthane, 4 joues, peigne auto-nettoyant avec pare-fils, roulements à billes de précision, distance entre les joues: env. 4,5 mm, épaisseur des joues: env. 4,0 mm.
Caractéristiques: longueur du profil: env. 2,75 mm, largeur de la rainure env. 5,7 mm, profondeur de la rainure: > 10,0 mm.

Renseignément:

Capacité de charge de 80 kg par roulette sur sols fixes, 40 kg par roulette pour tapis roulants. Nous attirons votre attention sur le fait que seulement les roues avec un diamètre minimum de 120 mm peuvent être utilisées sur les tapis roulants, selon la norme EN1929.

Fiche technique:

Diamètre de roue 125 mm - Largeur de bandage 32 mm - Trou central 13 mm - Déport 40 mm - Diamètre d'encombrement Ø 205 mm
Hauteur 153 mm, Résistance à la température - 40 / + 60 °C - Norme EN 12530 - Poids 0.73 kg - Rayon d'encombrement 102.5 mm,
Dureté du bandage shore D59 - Capacité de charge dynamique 80 kg - Capacité de charge statique 160 kg .

HANDLE POIGNEE
ERGOBOX



Our proven resistant ERGOBOX handle is the outcome of a meticulous study of ergonomics. Its handle design provides a comfortable use of the trolley. It comes with an integrated coin deposit system as well as with large advertising area.

La conception de notre poignée ERGOBOX, d'une grande robustesse, et résultat d'une étude ergonomique approfondie, vous offre un confort d'utilisation incomparable, ainsi qu'un grand espace publicitaire ou promotionnel. Possibilité d'intégrer un consigneur.

SCANNER HOLDER
SUPPORT SCANNER

MAGNIFYING GLASS
LOUPE RABATTABLE



Our scanner holder (Motorola or Metrologic) and the magnifying glass option to create the perfect handle layout.

Support scanner préparé pour "Motorola ou Metrologic". Loupe rabattable pour faciliter la lecture de l'information de certains produits. Deux accessoires essentiels pour avoir la poignée la plus complète.

SINGLE SCANNER HOLDER
SUPPORT SCANNER INDIVIDUEL



Easy use scanner holder (Motorola-Metrologic) available for ERGOGRIP and round handle.

Support scanner simple préparé pour "Motorola ou Metrologic", pour les poignées rondes et ERGOGRIP.

CUP HOLDER
SUPPORT Gobelets



Fully integrated and designed for the ERGOBOX handle, it supports all types of cups.

Le porte-gobelet, entièrement intégré et conçu pour notre poignée ERGOBOX, peut accueillir toutes sortes de canettes et gobelets.

PROMOBOX



The simplest way to maximise the advertisement area of the handle. Available for Ergogrip and round handle.

La façon la plus efficace d'obtenir plus d'espace publicitaire, valable aussi bien pour la poignée Ergogrip (ovale) que pour la poignée ronde.

ROUND HANDLE AND ERGOGRIP OVAL HANDLE
POIGNEE RONDE ET OVALE (ERGOGRIP)



Easy and comfortable options for trolley handling.

Options simples et confortables pour l'utilisation du chariot.

"PLUS" HANDLE SET
ENSEMBLE DES POIGNEES "PLUS"



ERGOBOX "PLUS"

ERGOGRIP "PLUS"

ROUND "PLUS"

Ergonomic vertical comfort grip "PLUS" for easy carriage handling, suitable for ERGOBOX, ERGOGRIP and ROUND handle.

Préhension verticale ergonomique "PLUS" pour un meilleur manoeuvrabilité du chariot. Adaptable aux poignées ERGOBOX, ERGOGRIP et RONDE.

RELAXT HANDLE
POIGNEE RELAXT



Handle solution for 80L and 98L trolleys because of its width.

Ergonomic and avant-garde design. Thanks to its integrated coin lock, it offers a large space for advertising. *Availability depending on model

Solution pour les modèles de chariots de 80L et de 98L. Design ergonomique et avant-gardiste. Avec son consigneur intégré, cette poignée vous offre également un espace publicitaire. *voir disponibilité par modèle.

ERGOBOX WITHOUT COIN LOCK
ERGOBOX SANS CONSIGNEUR



For more advertising space.

Pour plus d'espace publicitaire.

COIN LOCK

SMARTLOC



High quality coin locks.

Consigneur en plastique de haute qualité.

CONSIGNEURS

VARILOC



Heavy duty coin lock with metal finishing.

Finition métallique.

MULTIGRIP COIN LOCK AND SIDE COVER
CONSIGNEUR ET COUVERCLE LATÉRALE MULTIGRIP

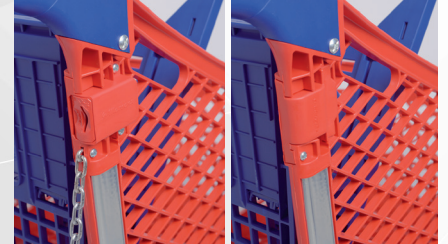

Our Multigrip trolley models have the option of side coin lock or side cover coin lock in its absence.

La gamme de chariots Multigrip dispose, en option, d'être équipée d'un consigneur latéral ou d'un couvercle latéral, si cette option n'est pas retenue.

GOODS SEPARATER
CLOISON DE SEPARATION DE PANIER



Perfect complement that allows to carry bag-packaged products and fragile items.

Complément idéal permettant de séparer des produits emballés ou fragiles.

ADVERTISEMENT HOLDER
SUPPORT PUBLICITAIRE



An effective way to increase the trolley profitability while attracting your customer's attention to your store promotions.

Outil intelligent qui permet d'optimiser la rentabilité de votre chariot grâce à la publicité, ainsi que de mettre en avant auprès de votre clientèle vos campagnes promotionnelles.

WIRE CRADLE
CORBEILLE SUPPORT COQUE BEBE



The perfect complement for every type of cradle.

Complément parfait pour transporter la coque bébé ou le couffin des clients.

BABY CRADLE
COQUE BEBE POUR CHARIOT



A very good option keeping the same trolley capacity.

Sa conception ainsi que les matériaux employés font du coque bébé le siège idéal pour les petits enfants, et ceci sans réduction du volume du panier.

DOUBLE FUNCTION BABY SEAT
PORTE-BEBE DOUBLE FONCTION

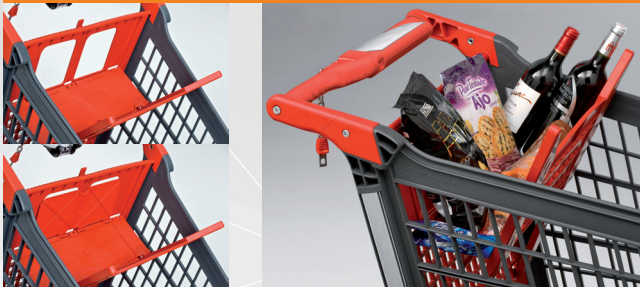

Get an extra loading place (specially to carry fragile products) by folding up the plastic baby seat.

Le volet rabattable du siège vous permet de disposer d'un espace supplémentaire idéal pour les produits fragiles.

FLAG POLE
MAT AVEC DRAPEAU



The most suitable complement to locate your trolley.

Complément parfait pour la localisation des chariots.

BOTTLE RACK
SUPPORT PACKS PLIABLE



Easy fold up / fold down bottle rack attachment. It is the ideal accessory to transport liquid or bottle packs.

Facilement rabattable, c'est l'accessoire idéal pour transporter des packs (boissons, lait...).

FRONT FIXED BOTTLE RACK
SUPPORT PACKS FIXE AVANT



Optional front bottle rack for 80L, 98L, 100L Multigrip trolleys, and for 90L and 110L Polysteel trolleys.

Solution pour le transport des packs pour les chariots Multigrip de 80L, 98L, 100L, ainsi que les chariots Polysteel de 90L et 110 L.

GRILL BASE
GRILLE INFÉRIEURE



Allows extra loading capacity on standard line trolleys. Perfect trolley nesting accuracy. It also allows its use in walkways.

Une solution pour augmenter la capacité de charge de votre chariot, adaptable uniquement sur les socles standard. L'inclinaison de la grille permet une meilleure tenue du produit, tout en permettant l'utilisation du chariot sur des rampes mécaniques.

COLOUR RANGE
GAMME DE COULEURS



RAL 5002	ULTRAMARINE BLUE	BLEU OUTREMERINE
RAL 3000	FLAME RED	ROUGE FEU
RAL 6029	MINT GREEN	VERT MENTHE
RAL 7015	SLATE GREY	GRIS ARDOISE
RAL 1018	ZINC YELLOW	JAUNE ZINC
* RAL 2003	ORANGE	ORANGE*
* RAL 9005	BLACK	NOIR*

* Standard colours only available for Multigrip 100L trolley (Consult other models)

*Couleurs standard disponibles uniquement pour les chariots Multigrip de 100L (merci de vérifier pour les autres modèles)

POLYSTEEL



STANDARD LINE GAMME STANDARD

P O L Y S T E E L 2 4 2 S T D



Ø125



CPSDF24203
22,6kg.

Ø125



CPSDF24208
22,6 kg.

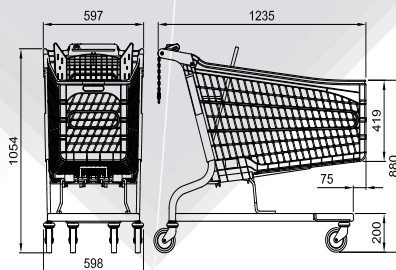

PARKING

- X 5 2,255 mts.
- x 10 3,530 mts.
- x 15 4,805 mts.
- x 25 7,355 mts.

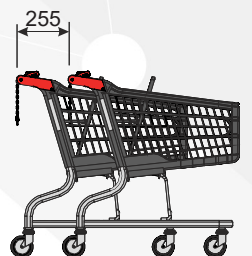



Ø125



3

CPSDF22003
21,1 kg

Ø125



8

CPSDF22008
21,1 kg.

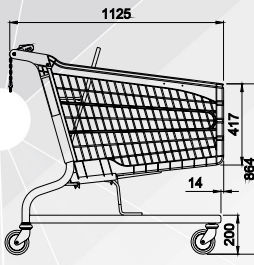
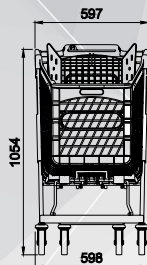

PARKING

- X 5 2,145 mts.
- x 10 3,420 mts.
- x 15 4,695 mts.
- x 25 7,245 mts.

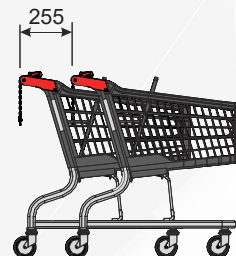

Ø125



3

CPSDF19503
19,7 kg.

Ø125



8

CPSDF19508
19,7 kg.

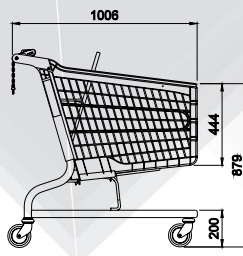
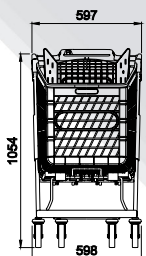

PARKING

- X 5 2,026 mts.
- x 10 3,301 mts.
- x 15 4,576 mts.
- x 25 7,126 mts.

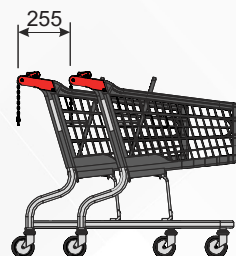



Ø125



3

Ø125



8

CPGDF16003-RP
21,3 kg.

CPGDF16008-RP
21,3 kg.

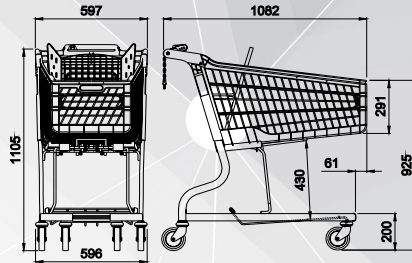

PARKING

- X 5 2,102 mts.
- x 10 3,377 mts.
- x 15 4,652 mts.
- x 25 7,202 mts.



Ø125



Ø125



CPGDF14003-RP
20,2 kg.

CPGDF14008-RP
20,2 kg.

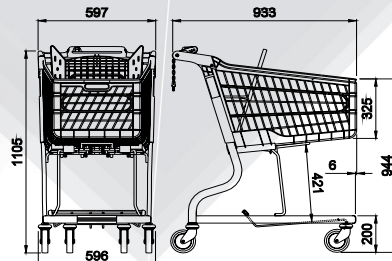

PARKING

- X 5 1,953 mts.
- x 10 3,228 mts.
- x 15 4,503 mts.
- x 25 7,053 mts.





Ø125



CPSDF16003
18,9 kg.

Ø125



CPSDF16008
18,9 kg.

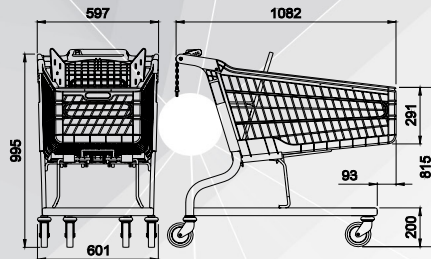

PARKING

X 5	2,102 mts.
x 10	3,377 mts.
x 15	4,652 mts.
x 25	7,202 mts.



POLYSTEEL 140 STD



Ø125



CPSDF14003
18,1 kg.

Ø125



CPSDF14008
18,1 kg.

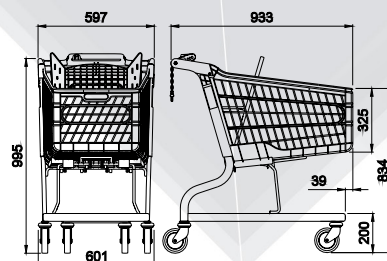

PARKING

X 5	1,953 mts.
x 10	3,228 mts.
x 15	4,503 mts.
x 25	7,053 mts.

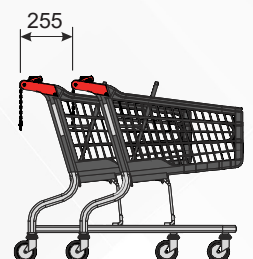



Ø125



CPSSP11003
17,5 kg.

Ø125



CPSSP11008
17,5 kg.

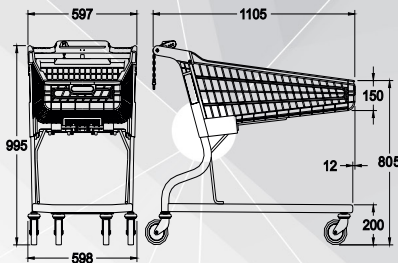

PARKING

- X 5 2,025 mts.
- x 10 3,174 mts.
- x 15 4,325 mts.
- x 25 6,625 mts.

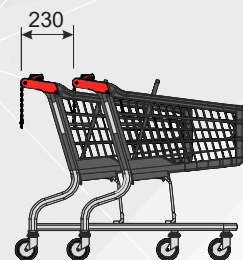

POLYSTEEL 90 STD



Ø125



CPSSP09003
15,8 kg.

Ø125



CPSSP09006
15,8 kg.

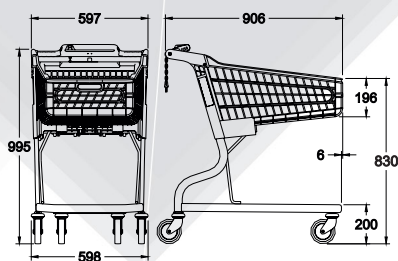

PARKING

- X 5 1,826 mts.
- x 10 2,976 mts.
- x 15 4,126 mts.
- x 25 6,426 mts.

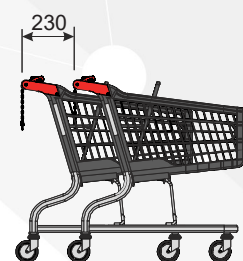

STANDARD LINE ACCESSORIES

ACCESSOIRES GAMME STANDARD

OPTIONAL STANDARD	EN OPTION DE SERIE	90	110	140	140 GC	160	160 GC	195	220	242
	ERGOBOX HANDLE POIGNEE ERGOBOX CMEBPS	●	●	●	●	●	●	●	●	●
	ERGOG RIP - FG HANDLE POIGNEE ERGOG RIP - FG CMEFGPS	●	●	●	●	●	●	●	●	●
	ROUND HANDLE POIGNEE RONDE CMRPS	●	●	●	●	●	●	●	●	●
	ERGOBOX PLUS HANDLE POIGNEE ERGOBOX PLUS CMEBPS P	●	●	●	●	●	●	●	●	●
	ERGOG RIP - FG PLUS HANDLE POIGNEE ERGOG RIP - FG PLUS CMEFGPSP	●	●	●	●	●	●	●	●	●
	ROUND PLUS HANDLE POIGNEE RONDE PLUS CMRPS P	●	●	●	●	●	●	●	●	●
	ERGOBOX SCANNER SUPPORT SUPPORT SCANNER ERGOBOX SSE	●	●	●	●	●	●	●	●	●
	ERGOG RIP-FG SCANNER SUPPORT SUPPORT SCANNER ERGOG RIP - FG SSIND	●	●	●	●	●	●	●	●	●
	ROUND HANDLE SCANNER SUPPORT SUPPORT SCANNER POIGNEE RONDE SSINDT	●	●	●	●	●	●	●	●	●
	PROMOBOX FOR ERGOG RIP - FG PROMOBOX POIGNEE ERGOG RIP - FG PMSEFG	●	●	●	●	●	●	●	●	●
	PROMOBOX FOR ROUND HANDLE PROMOBOX POIGNEE RONDE PMR	●	●	●	●	●	●	●	●	●
	CUP HOLDER SUPPORT GOBELET POIGNEE ERGOBOX SVMEBX	●	●	●	●	●	●	●	●	●
	FOLDING MAGNIFYING GLASS LOUPE RABATTABLE POIGNEE ERGOBOX LPMEBX	●	●	●	●	●	●	●	●	●
	DOUBLE FUNCTION BABY SEAT PORTE-BEBE DOUBLE FONCTION 9011RBDFPS (90-110 METALLIC) (METALLIQUE) CBAPBPS1416 (140-160) - CBAPBPS1920 (195-220-242)	●	●	●	●	●	●	●	●	●
	BACK FLAP WITHOUT BABY SEAT VOLET BATTANT SANS PORTE-BEBE RTPS9011 (90-110)	●	●	●	●	●	●	●	●	●
	BOTTLE RACK SUPPORT PACKS RBFP9011 (90-110) - RBPS (140-160-195-220-242)	●	●	●	●	●	●	●	●	●
	GRILL BASE GRILLE INFERIEURE RPPS90 (90) - RPPS110 (110) - RPLPS (140) RGLPS (160-195) - RPLPS220 (220)	●	●	●	●	●	●	●	●	●
	SHORT GRILL BASE GRILLE INFERIEURE COURTE (AVEC SUPPORT PACKS) RPCPS (140) - RGCPS (160-195) - RPCPS220 (220)	●	●	●	●	●	●	●	●	●
	GOODS SEPARATER CLOISON DE SEPARATION DE PANIER SPS14 (140) - SPS16 (160) - SPS19 (195) SPS22 (220) - SPS24 (240)	●	●	●	●	●	●	●	●	●
	FLAG POLE MAT AVEC DRAPEAU MBCP	●	●	●	●	●	●	●	●	●
	BABY CRADLE COQUE BEBE CCBD	●	●	●	●	●	●	●	●	●
	WIRE CRADLE CORBEILLE SUPPORT COQUE BEBE CSCP	●	●	●	●	●	●	●	●	●
	ADVERTISEMENT HOLDER SUPPORT PUBLICITAIRE PCPCP	●	●	●	●	●	●	●	●	●

POLYSTEEL



ANTI-THEFT LINE
GAMME SECURITE

P O L Y S T E E L 2 4 2 A T H



Ø125



CPADF24203
22,7 kg.

Ø125



CPADF24208
22,7 kg.

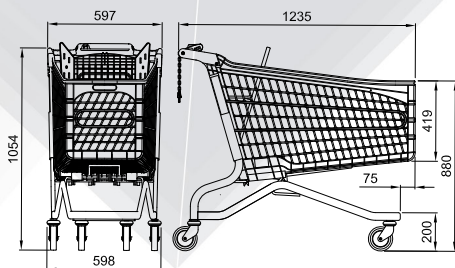

PARKING

- X 5 2,255 mts.
- x 10 3,530 mts.
- x 15 4,805 mts.
- x 25 7,355 mts.

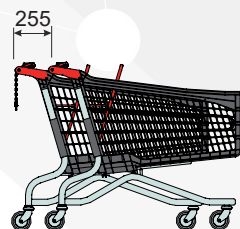



Ø125



CPADF22003
21,2 kg.

Ø125



CPADF22008
21,2 kg.

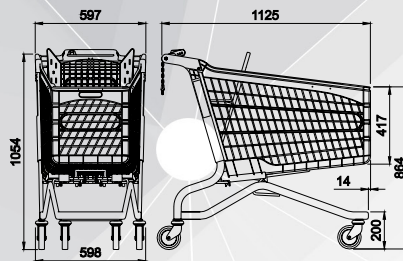

PARKING

X 5	2,145 mts.
x 10	3,420 mts.
x 15	4,695 mts.
x 25	7,245 mts.



P O L Y S T E E L 1 9 5 A T H



Ø125



CPADF19503
19,5 kg.

Ø125



CPADF19508
19,5 kg.

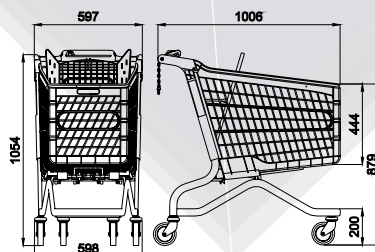

PARKING

X 5	2,026 mts.
x 10	3,301 mts.
x 15	4,576 mts.
x 25	7,126 mts.





Ø125



CPADF16003
18,9 kg.

Ø125



CPADF16008
18,9 kg.

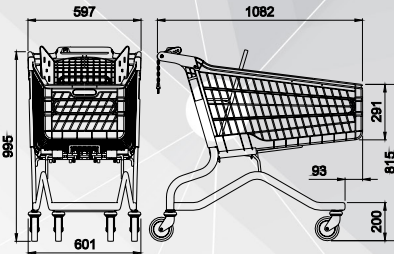

PARKING

- X 5 2,102 mts.
- x 10 3,377 mts.
- x 15 4,652 mts.
- x 25 7,202 mts.



POLYSTEEL 140ATH



Ø125



CPADF14003
18,2 kg.

Ø125



CPADF14008
18,2 kg.

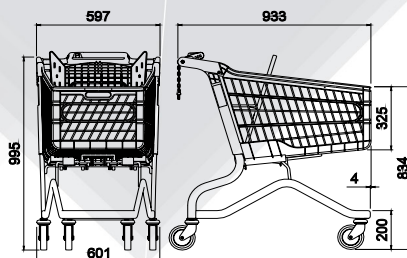

PARKING

- X 5 1,953 mts.
- x 10 3,228 mts.
- x 15 4,503 mts.
- x 25 7,053 mts.





Ø125



CPASP11003
16,4 kg.

Ø125



CPASP11008
16,4 kg.

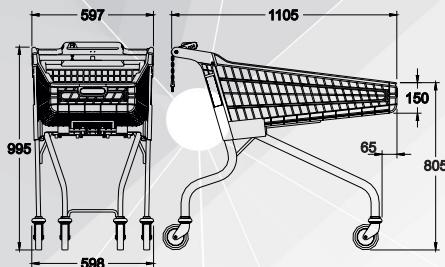

PARKING

- X 5 2,025 mts.
- x 10 3,174 mts.
- x 15 4,325 mts.
- x 25 6,625 mts.



* POLYSTEEL 90ATH



Ø125



CPASP09003
14,9 kg.

Ø125



CPASP09008
14,9 kg.

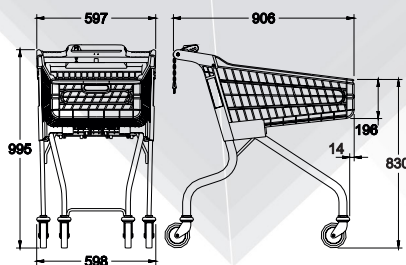

PARKING

- X 5 1,826 mts.
- x 10 2,976 mts.
- x 15 4,126 mts.
- x 25 6,426 mts.



ACCESSORIES ATH

ACCESSOIRES GAMME SECURITE

OPTIONAL STANDARD	EN OPTION DE SERIE		90	110	140	160	195	220	242
	ERGOBOX HANDLE POIGNEE ERGOBOX CMEBPS		●	●	●	●	●	●	●
	ERGOGRIP - FG HANDLE POIGNEE ERGOGRIP - FG CMEFGPS		●	●	●	●	●	●	●
	ROUND HANDLE POIGNEE RONDE CMRPS		●	●	●	●	●	●	●
	ERGOBOX PLUS HANDLE POIGNEE ERGOBOX PLUS CMEBPSP		●	●	●	●	●	●	●
	ERGOGRIP - FG PLUS HANDLE POIGNEE ERGOGRIP - FG PLUS CMEFGPSP		●	●	●	●	●	●	●
	ROUND PLUS HANDLE POIGNEE RONDE PLUS CMRPSP		●	●	●	●	●	●	●
	ERGOBOX SCANNER SUPPORT SUPPORT SCANNER ERGOBOX SSE		●	●	●	●	●	●	●
	ERGOGRIP-FG SCANNER SUPPORT SUPPORT SCANNER ERGOGRIP - FG SSIND		●	●	●	●	●	●	●
	ROUND HANDLE SCANNER SUPPORT SUPPORT SCANNER POIGNEE RONDE SSINDT		●	●	●	●	●	●	●
	PROMOBOX FOR ERGOGRIP - FG PROMOBOX POIGNEE ERGOGRIP - FG PMSEFG		●	●	●	●	●	●	●
	PROMOBOX FOR ROUND HANDLE PROMOBOX POIGNEE RONDE PMR		●	●	●	●	●	●	●
	CUP HOLDER SUPPORT Gobelet POIGNEE ERGOBOX SVMEBX		●	●	●	●	●	●	●
	FOLDING MAGNIFYING GLASS LOUPE RABATTABLE POIGNEE ERGOBOX LPMEBX		●	●	●	●	●	●	●
	DOUBLE FUNCTION BABY SEAT PORTE-BEBE DOUBLE FONCTION 9011RBDFPS (90-110 METALLIC) (METALLIQUE) CBAPBPS1416 (140-160) - CBAPBPS1920 (195-220-242)		●	●	●	●	●	●	●
	BACK FLAP WITHOUT BABY SEAT VOLET BATTANT SANS PORTE-BEBE RTPS9011 (90-110)		●	●	●	●	●	●	●
	BOTTLE RACK SUPPORT PACKS RBPS (140-160) - RBPAP (195-220-42)				●	●	●	●	●
	FRONT BOTTLE RACK SUPPORT PACKS AVANT RBFDPAP90 (90) - RBFDPAP110 (110)		●	●					
	GOODS SEPARATER CLOISON DE SEPARATION DE PANIER SPS14 (140) - SPS16 (160) - SPS19 (195) SPS22 (220) - SPS24 (240)				●	●	●	●	●
	FLAG POLE MAT AVEC DRAPEAU MBCP		●	●	●	●	●	●	●
	BABY CRADLE COQUE BEBE CCBD		●	●	●	●	●	●	●
	WIRE CRADLE CORBEILLE SUPPORT COQUE BEBE CSCP		●	●	●	●	●	●	●
	ADVERTISEMENT HOLDER SUPPORT PUBLICITAIRE PCPCP				●	●	●	●	●



Ø125



CPGSP11003
22,9 kg.

Ø125



CPGSP11008
22,9 kg.

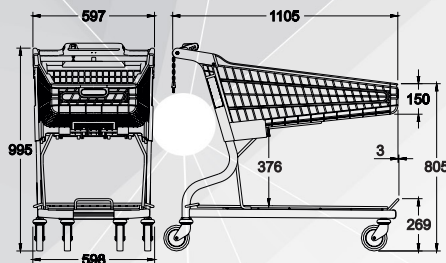

PARKING

- X 5 2,025 mts.
- x 10 3,174 mts.
- x 15 4,325 mts.
- x 25 6,625 mts.

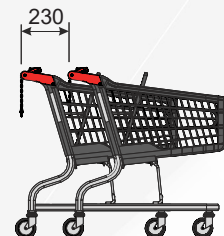

Ø125



CPBSP11003
25,7 kg.

Ø125



CPBSP11008
25,7 kg.

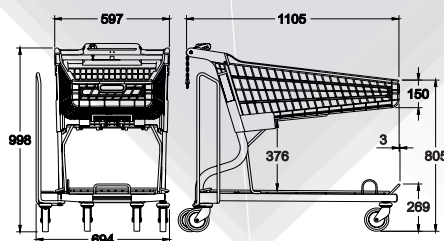

PARKING

- X 5 2,025 mts.
- x 10 3,174 mts.
- x 15 4,325 mts.
- x 25 6,625 mts.

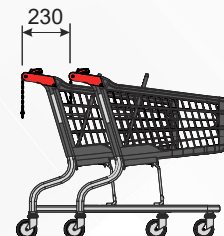



Ø125



CPGSP09003
20,4 kg.

Ø125



CPGSP09008
20,4 kg.

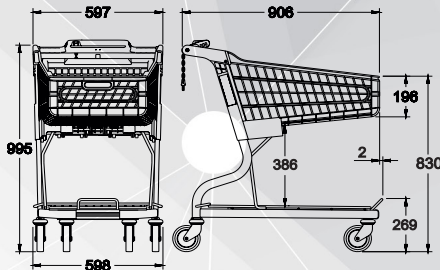

PARKING

- X 5 1,826 mts.
- x 10 2,976 mts.
- x 15 4,126 mts.
- x 25 6,426 mts.



Ø125



CPGGSP9003
22 kg.

Ø125



CPGGSP9008
22 kg.

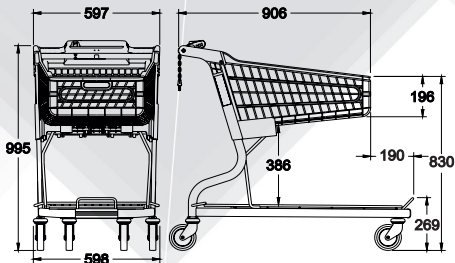

PARKING

- X 5 2,016 mts.
- x 10 3,166 mts.
- x 15 4,316 mts.
- x 25 6,616 mts.

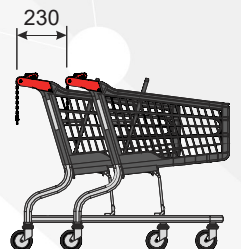



Ø125



CPBSP09003
23,1 kg.

Ø125



CPBSP09008
23,1 kg

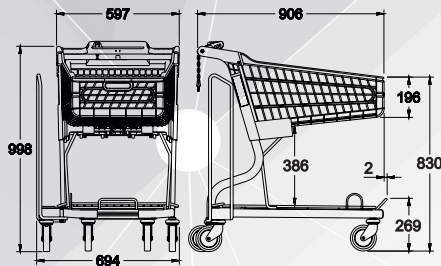

PARKING

X 5	1,826 mts.
x 10	2,976 mts.
x 15	4,126 mts.
x 25	6,426 mts.

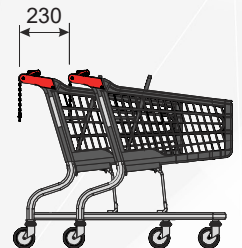

Ø125



CPBGSP9003
24,7 kg.

Ø125



CPBGSP9008
24,7 kg.

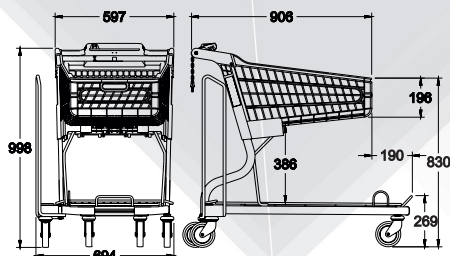

PARKING

X 5	2,016 mts.
x 10	3,166 mts.
x 15	4,316 mts.
x 25	6,616 mts.

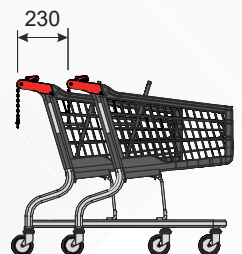

ACCESSORIES "BGA"

ACCESSOIRES GAMME BGA

OPTIONAL ● EN OPTION ●		90TG	90TG GC	90TB	90TB GC	110TG	110TB
STANDARD ● DE SERIE ●							
	ERGOBOX HANDLE POIGNEE ERGOBOX CMEBPS	●	●	●	●	●	●
	ERGOGRIP - FG HANDLE POIGNEE ERGOGRIP - FG CMEFGPS	●	●	●	●	●	●
	ROUND HANDLE POIGNEE RONDE CMRPS	●	●	●	●	●	●
	ERGOBOX PLUS HANDLE POIGNEE ERGOBOX PLUS CMEBPSP	●	●	●	●	●	●
	ERGOGRIP - FG PLUS HANDLE POIGNEE ERGOGRIP - FG PLUS CMEFGPSP	●	●	●	●	●	●
	ROUND PLUS HANDLE POIGNEE RONDE PLUS CMRPSP	●	●	●	●	●	●
	ERGOBOX SCANNER SUPPORT SUPPORT SCANNER ERGOBOX SSE	●	●	●	●	●	●
	ERGOGRIP-FG SCANNER SUPPORT SUPPORT SCANNER ERGOGRIP - FG SSIND	●	●	●	●	●	●
	ROUND HANDLE SCANNER SUPPORT SUPPORT SCANNER POIGNEE RONDE SSINDT	●	●	●	●	●	●
	PROMOBOX FOR ERGOGRIP - FG PROMOBOX POIGNEE ERGOGRIP - FG PMSEFG	●	●	●	●	●	●
	PROMOBOX FOR ROUND HANDLE PROMOBOX POIGNEE RONDE PMR	●	●	●	●	●	●
	CUP HOLDER SUPPORT GOBELET POIGNEE ERGOBOX SVMEBX	●	●	●	●	●	●
	FOLDING MAGNIFYING GLASS LOUPE RABATTABLE POIGNEE ERGOBOX LPMEBX	●	●	●	●	●	●
	DOUBLE FUNCTION BABY SEAT PORTE-BEBE DOUBLE FONCTION 9011RBDFPS (90-110) METALLIC / METALLIQUE	●	●	●	●	●	●
	BACK FLAP WITHOUT BABY SEAT VOLET BATTANT SANS PORTE-BEBE RTPS9011 (90-110)	●	●	●	●	●	●
	TRAY BASE FOR TECHNO-GARDEN GRILLE INFERIEURE TECHNO-GARDEN / CHARIOT JARDINERIE 90TGP2 (90) - 110TGP2 (110)	●	●			●	
	TRAY BASE FOR TECHNO-D.I.Y GRILLE INFERIEURE TECHNO-BRICOLAGE / TECHNO DIY 90TBP2 (90) - 110TBP2 (110)			●	●		●
	SIDE RACK PORTE-PANNEAUX PTT03			●	●		●
	FLAG POLE MAT AVEC DRAPEAU MBCP	●	●	●	●	●	●
	BABY CRADLE COQUE BEBE CCBD	●	●	●	●	●	●
	ADVERTISEMENT HOLDER SUPPORT PUBLICITAIRE CSCP	●	●	●	●	●	●



MULTIGRIP

M U L T I G R I P 1 5 0 FOR CRATES - GRANDE CHARGE



Ø125



CPMGDF1503-RP
21,3 KG

Ø125



CPMGDF1508-RP
21,3 KG

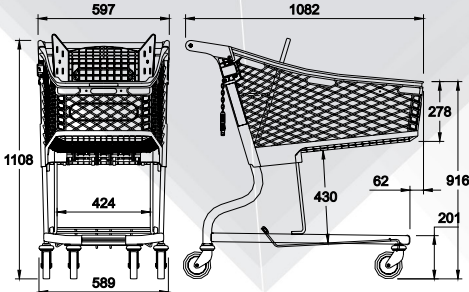

PARKING

- X 5 2,082 mts.
- x 10 3,332 mts.
- x 15 4,582 mts.
- x 25 7,082 mts.

250 mm.





Ø125



CPMSDF1503
19,5 KG.

Ø125



CPMSDF1508
19,5 KG.

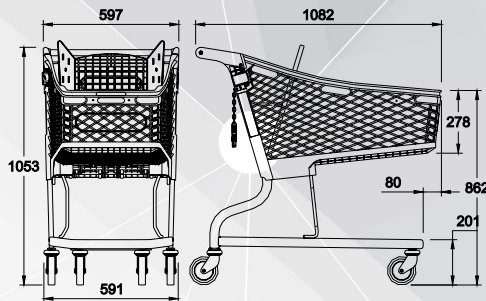

PARKING

- X 5 2,082 mts.
- x 10 3,332 mts.
- x 15 4,582 mts.
- x 25 7,082 mts.

250 mm.



Ø125



CPMSDF1303
18,9 KG.

Ø125



CPMSDF1308
18,9 KG.

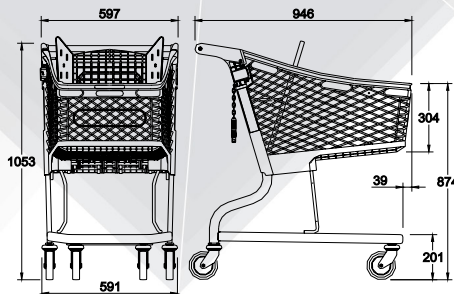

PARKING

- X 5 1,946 mts.
- x 10 3,196 mts.
- x 15 4,446 mts.
- x 25 6,946 mts.

250 mm.





Ø125



CPMADF1503
18,3 KG.

Ø125



CPMADF1508
18,3 KG.

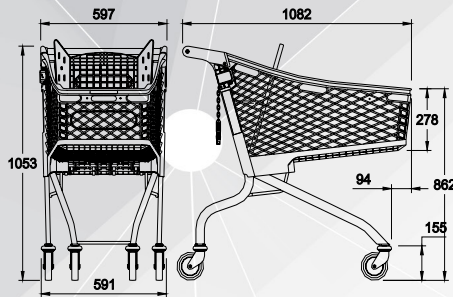

PARKING

X 5	2,082 mts.
x 10	3,332 mts.
x 15	4,582 mts.
x 25	7,082 mts.

250 mm.



Ø125



CPMADF1303
17,7 KG.

Ø125



CPMADF1308
17,7 KG.

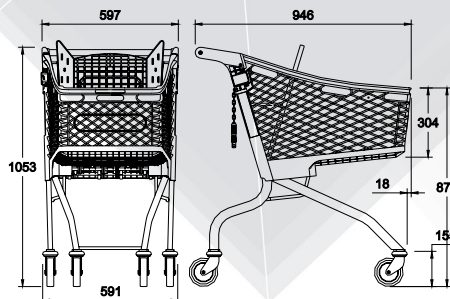

PARKING

X 5	1,946 mts.
x 10	3,196 mts.
x 15	4,446 mts.
x 25	6,946 mts.

250 mm.





CPMASP1002B-RB
13,4 KG.



CPMASP1002B
12,5 KG

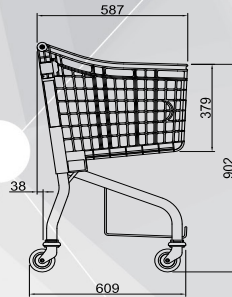
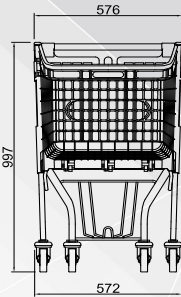

PARKING

- X 5 1,087 mts.
- X 10 1,712 mts.
- X 15 2,337 mts.
- X 25 3,587 mts.

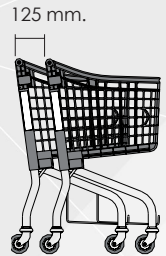

CPMASP1008-RB
14,1 KG



CPMASP1008
13,4 KG

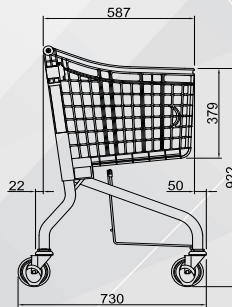
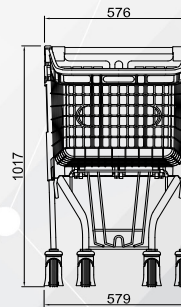

PARKING

- X 5 1,417 mts.
- X 10 2,392 mts.
- X 15 3,367 mts.
- X 25 5,317 mts.

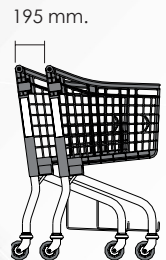



Ø100



CPMADF9802
15,2 KG.

Ø125



CPMADF9808
16 KG.

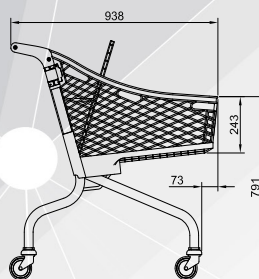
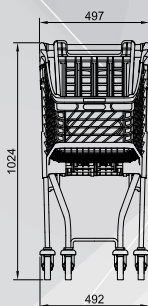

PARKING

- X 5 1,818 mts.
- x 10 2,918 mts.
- x 15 4,018 mts.
- x 25 6,218 mts.



Ø100



CPMADF8002
14,6 KG.

Ø125



CPMADF8008
15,4 KG.

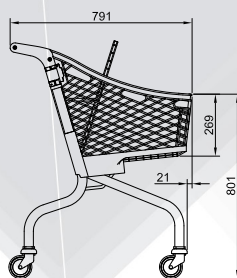
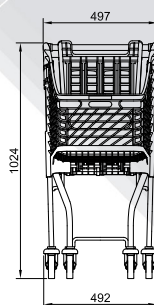

PARKING

- X 5 1,671 mts.
- x 10 2,771 mts.
- x 15 3,871 mts.
- x 25 6,071 mts.



MULTIGRIP ACCESSORIES

ACCESSOIRES MULTIGRIP

OPTIONAL STANDARD	● ●	EN OPTION DE SERIE	● ●	130 STD	150 STD	150 GC	80 ATH	98 ATH	100 ATH	130 ATH	150 ATH
		ERGOBOX HANDLE / RELAXT HANDLE (80 - 98) POIGNEE ERGOBOX / POIGNEE RELAXT (80 - 98) CMEBPS / MRLXT465 (80 - 98)		●	●	●	●	●		●	●
		ERGOGRIP - FG HANDLE POIGNEE ERGOGRIP - FG CMEFGPS		●	●	●	●	●		●	●
		ROUND HANDLE POIGNEE RONDE CMRPS		●	●	●	●	●	●	●	●
		ERGOBOX PLUS HANDLE POIGNEE ERGOBOX PLUS CMEBPSP		●	●	●				●	●
		ERGOGRIP - FG PLUS HANDLE POIGNEE ERGOGRIP - FG PLUS CMEFGPSP		●	●	●				●	●
		ROUND PLUS HANDLE POIGNEE RONDE PLUS CMRPSP		●	●	●				●	●
		SCANNER SUPPORT / ERGOBOX CUP HOLDER SUPPORT SCANNER / SUPPORT Gobelet POIGNEE ERGOBOX SSE / SVMEX		●	●	●				●	●
		ERGOGRIP-FG SCANNER SUPPORT SUPPORT SCANNER ERGOGRIP - FG SSIND		●	●	●	●	●		●	●
		ROUND HANDLE SCANNER SUPPORT SUPPORT SCANNER POIGNEE RONDE SSINDT		●	●	●	●	●	●	●	●
		PROMOBOX FOR ERGOGRIP - FG PROMOBOX POIGNEE ERGOGRIP - FG PMSEFG		●	●	●	●	●		●	●
		PROMOBOX FOR ROUND HANDLE PROMOBOX POIGNEE RONDE PMR		●	●	●	●	●	●	●	●
		FOLDING MAGNIFYING GLASS LOUPE RABATTABLE POIGNEE ERGOBOX LPMEBX		●	●	●	●	●		●	●
		DOUBLE FUNCTION BABY SEAT PORTE-BEBE DOUBLE FONCTION CBAPBPS1416 (130-150) - CBAPBPM8098 (80-98)		●	●	●	●	●		●	●
		BACK FLAP WITHOUT BABY SEAT VOLET BATTANT SANS PORTE-BEBE RTPSMG8098 (80-98) - RTPSMG100 (100)		●	●	●	●	●	●	●	●
		FRONT BOTTLE RACK SUPPORT PACKS AVANT RBPAPM100 (100) RBPAPM80 (80) - RBPAPM98 (98)					●	●	●		
		BOTTLE RACK SUPPORT PACKS RBPS (130-150 STD) - RBPAPM1315 (130-150 ATH)		●	●					●	●
		GRILL BASE GRILLE INFERIEURE RPLPS (130) - RGLPS (150)		●	●	●					
		SHORT GRILL BASE GRILLE INFERIEURE COURTE (AVEC SUPPORT PACKS) RPCPS (130) - RGCPS (150)		●	●						
		GOODS SEPARATER CLOISON DE SEPARATION DE PANIER SPS13 (130) - SPS15 (150)		●	●	●				●	●
		FLAG POLE MAT AVEC DRAPEAU MBCP		●	●	●	●	●	●	●	●
		BABY CRADLE COQUE BEBE CSCP		●	●	●				●	●
		WIRE CRADLE CORBEILLE SUPPORT COQUE BEBE CCBD		●	●	●				●	●
		ADVERTISEMENT HOLDER SUPPORT PUBLICITAIRE PCPCP		●	●	●			●	●	●



The trolley is the first contact of your business with the client, and the main reflection of your brand. A personalised trolley shelter will enhance the image of your business according to its environment. Contact us for personalised projects.



Les abris et les chariots sont le premier contact des clients avec votre magasin, ainsi que le principal reflet de votre enseigne. Nos abris à chariots personnalisés renforceront l'image de votre magasin et s'intégreront dans votre environnement. Contactez-nous pour des projets sur mesure.



END INFORMATION BAR WITHOUT SIDE GUIDANCE BARS
 TETE DE STATION SANS BARRE DE GUIDAGE INTEGREE

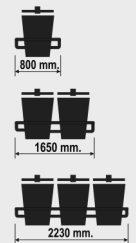
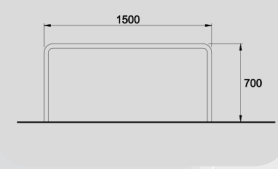
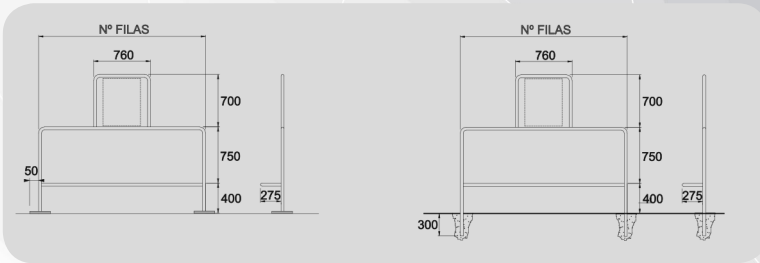
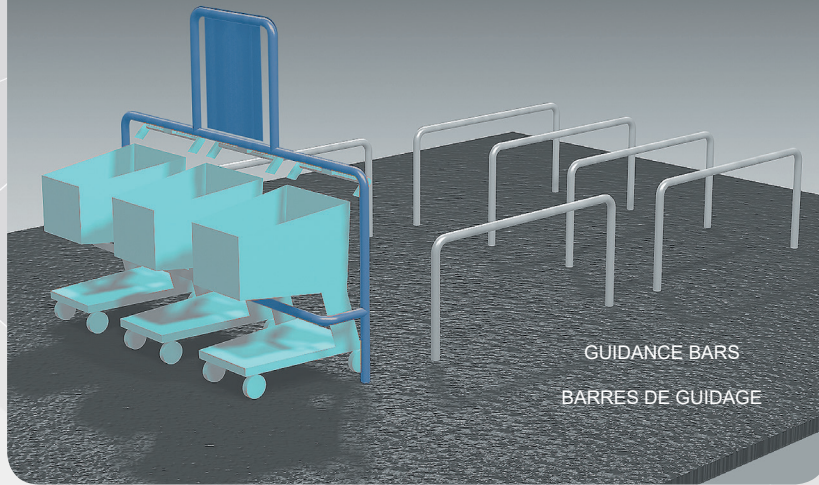

END INFORMATION BAR WITH SIDE GUIDANCE BARS
 TETE DE STATION AVEC BARRES DE GUIDAGE INTEGREEES

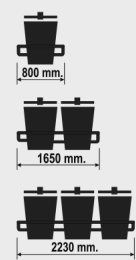
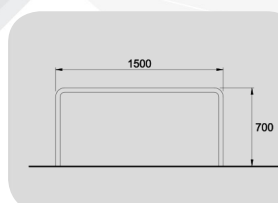
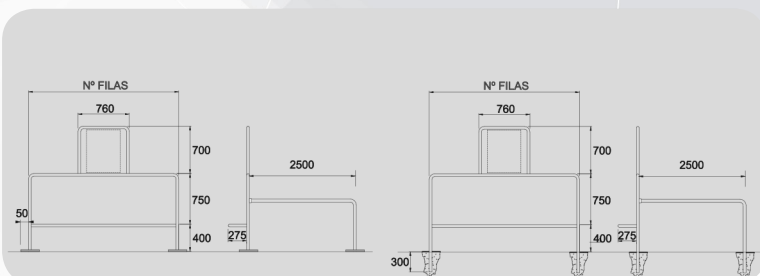
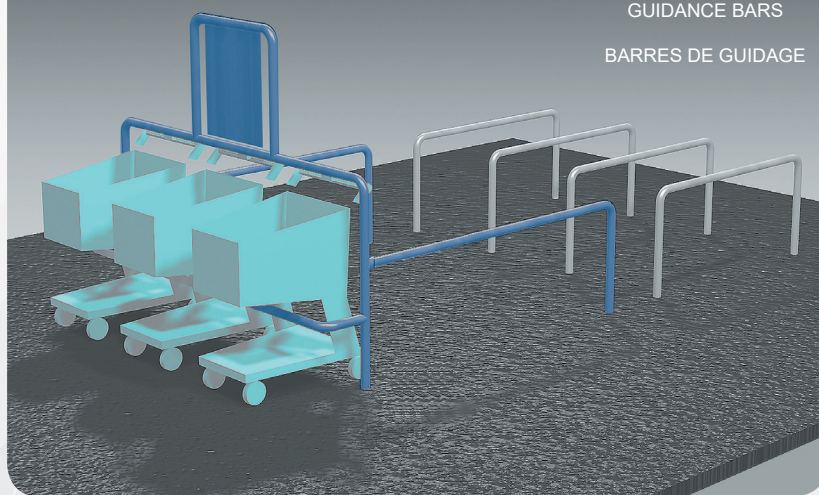

Always keeping in mind our values towards our customers

**QUALITY
INNOVATION
EMOTION**



En gardant toujours à l'esprit nos valeurs envers nos clients

**QUALITE
INNOVATION
EMOTION**



www.marsanz.es



HEAD OFFICE
SIEGE SOCIAL

CALLE HIERRO, 27
28850 TORREJON DE ARDOZ
MADRID
ESPAÑA - SPAIN

TEL.: (34) 91 675 14 34 // (34) 91 677 10 92
FAX.: (34) 91 675 12 90
E-MAIL.: export@marsanz.es
creaciones@marsanz.es

PRODUCTION FACILITIES
USINES

TORREJON DE ARDOZ (MADRID)
UGENA (TOLEDO)

INTERNATIONAL
INTERNATIONAL

EXPORT DIVISION
E-MAIL.: export@marsanz.es

FRANCE
FRANCE

MARSANZ FRANCE SAS

13 RUE SAINT HONORE
78000 VERSAILLES

TÉL.: +33 (0) 1 30 88 82 95
E-MAIL.: info@marsanz.fr
www.marsanz.fr

UNITED KINGDOM
ROYAUME-UNI

MARSANZ UK Ltd.

46 BEVERLEY ROAD
LEAMINGTON SPA
WARWICKSHIRE CV32 6PJ
PHONE.: +44 (0) 1618818515
E-MAIL.: info@marsanz.co.uk
www.marsanz.uk

DISTRIBUTED BY **DISTRIBUE PAR**

SPANISH BRANCHES
DELEGATIONS EN ESPAGNE

BARCELONA

POLIGONO INDUSTRIAL MOLI D'EN XECH
Calle Barneda, Nº 17 nave 25
Frente Río Ripoll
08291 - RIPOLLET

TEL.: 93 231 34 75
FAX.: 93 231 35 47
E-MAIL.: barcelona@marsanz.es

SEVILLA

AVDA. DEL PARSÍ
POL.IND. MINI PARSÍ, NAVE 9
41016 SEVILLA

TEL.: 95 451 12 45
FAX.: 95 425 85 09
E-MAIL.: andalucia@marsanz.es

ALICANTE

C/ CAMPELLO, 13
POL.IND. LA CALA
03509 FINESTRAT - ALICANTE

TEL.: 96 680 27 04
FAX.: 96 683 07 96
E-MAIL.: levante@marsanz.es

