

Híbridos

Hybrid



Carros de autoservicio
Einkaufswagen

ES DE

Marsanz

6

SUMARIO

INHALTSVERZEICHNIS

CERTIFICADOS - PRODUKTZERTIFIKAT	2 - 3
ESPECIFICACIONES TÉCNICAS - TECHNISCHEN SPEZIFIKATIONEN	4 - 5
ACCESORIOS Y COMPLEMENTOS - ZUBEHÖR UND ERGÄNZUNGEN	6 - 7
POLYSTEEL GAMA STANDARD - POLYSTEEL STANDARDSORTIMENT	
242 L STD	8
220 L STD - 195 L STD	9
160 L STD - 140 L STD (GRAN CARGA - GROSSE BELASTUNG)	10
160 L STD - 140 L STD	11
110 L STD - 90 L STD	12
ACCESORIOS STD - STANDARDZUBEHÖR	13
POLYSTEEL GAMA ANTIHURTO - POLYSTEEL DIEBSTAHLSCHUTZSORTIMENT	
242 L ATH	14
220 L ATH - 195 L ATH	15
160 L ATH - 140 L ATH	16
110 L ATH - 90 L ATH	17
ACCESORIOS ATH - DIEBSTAHLSCHUTZ ZUBEHÖR	18
POLYSTEEL GAMA BGA - POLYSTEEL SORTIMENT BGA	
110 L TECHNO-GARDEN - TECHNO GARTEN	19
110 L TECHNO-BRICO LAJE - TECHNO HEIMWERKERARBEIT	19
90 L TECHNO-GARDEN - TECHNO GARTEN	20
90 L TECHNO-GARDEN GRAN CARGA - TECHNO GARTEN GROSSE BELASTUNG	20
90 L TECHNO-BRICO LAJE - TECHNO HEIMWERKERARBEIT	21
90 L TECHNO-BRICO LAJE GRAN CARGA - TECHNO HEIMWERKERARBEIT GROSSE BELASTUNG	21
ACCESORIOS BGA - BGA ZUBEHÖR	22
MULTIGRIP	
150 L STD GRAN CARGA - GROSSE BELASTUNG	23
150 L STD - 130 L STD	24
150 L ATH - 130 L ATH	25
100 L ATH	26
98 L ATH - 80 L ATH	27
ACCESORIOS MULTIGRIP - MULTIGRIP ZUBEHÖR	28
CUBRE CARROS - PARKBOX	29
PARKING CARROS - REIHENANFANGSTATION FÜR EKW	30

CREACIONES MARSANZ, s.a. se reserva el derecho de modificación, sin previo aviso, de todo el producto expuesto en el presente catálogo. Asimismo, queda prohibida la reproducción total o parcial del mismo.

CREACIONES MARSANZ, s.a. behält sich das Recht vor, ohne vorherige Ankündigung, jede in diesem Katalog beschriebenen Produkte vorzunehmen. Die teilweise oder vollständige Vervielfältigung unseres Katalogs ist auch verboten.

POLYSTEEL

AENOR

Certificado AENOR de Producto Carros de compra



A12/000003

AENOR certifica que la organización

CREACIONES MARSANZ, S.A.

con domicilio social en CL HIERRO, 27 - 28850 TORREJON DE ARDOZ (Madrid - España)

suministra Carros de compra de plástico para usuarios de supermercado e hipermercado

conformes con UNE-EN ISO 4892-2:2006/A1:2010 (EN ISO 4892-2:2006/A1:2009)
UNE-EN 1929-1:1998 (EN 1929-1:1998)
UNE-EN 1929-2:2005 (EN 1929-2:2004)
UNE-EN 1929-3:2005 (EN 1929-3:2005)
UNE-EN 1929-4:2005 (EN 1929-4:2005)
UNE-EN 1929-7:2005 (EN 1929-7:2005)

Referencias Detalladas en el Anexo al Certificado

Centro de producción CL HIERRO, 27 - 28850 TORREJON DE ARDOZ (Madrid - España)

Esquema de certificación Para conceder este Certificado, AENOR ha ensayado el producto y ha comprobado el sistema de la calidad aplicado para su elaboración. AENOR realiza estas actividades periódicamente mientras el Certificado no haya sido anulado, según se establece en el Reglamento Particular RP A12.01.

Fecha de primera emisión 2013-12-11

Fecha de última emisión 2018-12-11

Fecha de expiración 2023-12-11

Rafael GARCÍA MEIRO
Director General

Original Electrónico

AENOR INTERNACIONAL S.A.U.
Génova, 6. 28004 Madrid. España
Tel. 91 432 60 00.- www.aenor.com

AENOR

Certificado AENOR de Producto Carros de compra



A12/000006

AENOR certifica que la organización

CREACIONES MARSANZ, S.A.

con domicilio social en CL HIERRO, 27 - 28850 TORREJON DE ARDOZ (Madrid - España)

suministra Carros de compra de plástico para usuarios de supermercado e hipermercado

conformes con UNE-EN ISO 4892-2:2006/A1:2010 (EN ISO 4892-2:2006/A1:2009)
UNE-EN 1929-1:1998 (EN 1929-1:1998)
UNE-EN 1929-2:2005 (EN 1929-2:2004)
UNE-EN 1929-3:2005 (EN 1929-3:2005)
UNE-EN 1929-4:2005 (EN 1929-4:2005)

Referencias Detalladas en el Anexo al Certificado

Centro de producción CL HIERRO, 27 28850 TORREJON DE ARDOZ (Madrid - España)

Esquema de certificación Para conceder este Certificado, AENOR ha ensayado el producto y ha comprobado el sistema de la calidad aplicado para su elaboración. AENOR realiza estas actividades periódicamente mientras el Certificado no haya sido anulado, según se establece en el Reglamento Particular RP A12.01.

Fecha de primera emisión 2017-03-16
Fecha de expiración 2022-03-16

Avelino BRITO MARQUINA
Director General

Original Electrónico

AENOR INTERNACIONAL S.A.U.
Génova, 6. 28004 Madrid. España
Tel. 91 432 60 00 - www.aenor.com

CARACTERÍSTICAS

CARROS SERIES POLYSTEEL / MULTIGRIP: compuestos por un cesto en material polimérico de polipropileno y una plataforma de tubo metálica. Las plataformas disponen de distintos tipos de rueda para adaptar los carros a las superficies de uso. El mango del carro está disponible tanto en tubo metálico como en material polimérico termoplástico.

CARROS FABRICADOS DE ACUERDO A LOS REQUISITOS RECOGIDOS EN LA NORMA: UNE EN 1929-1 / UNE EN 1929-2 / UNE EN 1929-3 / UNE EN 1929-4 / UNE EN 1929-7

MATERIALES

MANGOS

Mangos metálicos: mango de tubo diámetro 25 x 1.5 mm de espesor, fabricado en acero electrocincado de primera calidad, con embuticiones en los extremos para evitar su giro, recubierto con adhesivo plastificado para serigrafía personalizada y con funda de PVC transparente para mayor protección UV.

Mangos poliméricos termoplásticos:

Mango ERGOBOX: fabricado en material polimérico ASA/PC (Acrilonitrilo estireno/polycarbonato) que le confiere tanto alta resistencia a los impactos como alta rigidez. Presenta buena resistencia a la radiación ultravioleta, intemperie y calor.

Mango ERGOGRIP: fabricado en PVC.

CESTO Y REJILLA TRASERA

Cesto y rejilla trasera carro Serie POLYSTEEL / MULTIGRIP: fabricados en material polimérico de polipropileno inyectado con protección contra radiación UV; resistente a ácidos, detergentes y soluciones salinas, exento de incompatibilidad electromagnética. Excelente grado de transparencia de cuadrícula estructural.

PLATAFORMA

Carro Serie POLYSTEEL / MULTIGRIP: Plataforma metálica de acero, fabricada con materiales de primera calidad conforme a las normas UNE EN 16120 Parte 2 / UNE EN 10305, compuesta por varillas de diámetros de 11,8 y 13,5 mm, por tubos ovales de 40 x 20 x 2 y por pletinas de anclaje de ruedas con espesores de 8 mm.

Uniones soldadas con penetraciones medias del 15% en el caso de las varillas, y por aportaciones en el resto de uniones.

REVESTIMIENTOS

Zincado: Tratamiento de Zinc electrolítico con un recubrimiento de 10 a 25 micras.

Poliéster transparente con aplicación electrostática en polvo de 90 a 100 micras y polimerizado a 200 °C.

CONFORT, ERGONOMÍA, SEGURIDAD Y TECNOLOGÍA RFID

Cumpliendo todos los requisitos de confort, ergonomía y seguridad conforme a

UNE EN 1929-1 / UNE EN 1929-2 / UNE EN 1929-3 / UNE EN 1929-4 / UNE EN 1929-7

Carro adaptado para la identificación y facturación automática mediante el sistema de etiquetado electrónico.

Compatible con RFID (Identificación por radiofrecuencia).

*Pendiente de certificación.

EIGENSCHAFTEN

POLYSTEEL UND MULTIGRIP EINKAUFSWAGEN

Bestehend aus einem Korb aus Polypropylen-Polymermaterial und einer Metallrohrplattform. Die Plattformen haben verschiedene Arten von Rädern, um die Einkaufswagen an die Oberflächen der Nutzung anzupassen.

Der Einkaufswagen handgriff ist sowohl aus Metallrohr als auch aus thermoplastischem Polymermaterial erhältlich

EINKAUFSWAGEN HERGESTELLT NACH DEN VORSCHRIFTEN DES NORMEN:

UNE EN 1929-1 / UNE EN 1929-2 / UNE EN 1929-3 / UNE EN 1929-4 / UNE EN 1929-7

MATERIALEN

GRIFFE

Metallgriffe: Rohrgriffdurchmesser 25 x 1,5 mm aus hochwertigem elektrolytisch verzinktem Stahl mit einer Prägung an den Enden, um die Drehung zu verhindern. Mit plastifiziertem Kleberband für den personalisierten Siebdruck und transparenter PVC-Ummantelung für besseren UV-Schutz.

Polymer-Thermoplast griffe

ERGOBOX-Griff: Aus Polymermaterial ASA / PC (Styrol-Acrylnitril-Copolymer / Polycarbonat), das ihm eine hohe Schlagfestigkeit und Steifigkeit verleiht. Es hat eine gute Beständigkeit gegen UV-Strahlung, Witterungseinflüsse und Hitze.

ERGOGRIFF Griff: aus PVC hergestellt

KORB UND RUCKGITTER

Korb- und Ruckgitter der Serie POLYSTEEL / MULTIGRIP: aus eingespritztem Polypropylen-Polymermaterial mit UV-Strahlenschutz; Beständig gegen Säuren, Reinigungsmittel und Salzlösungen, frei von elektromagnetischer Unverträglichkeit. Hervorragende Transparenz des Tragwerksgitters.

PLATTFORM

Einkaufswagen der Serie POLYSTEEL / MULTIGRIP: Plattform aus Metallstahl, hergestellt aus hochwertigen Materialien gemäß den Normen UNE EN 16120 Teil 2 / UNE EN 10305, bestehend aus Stangen mit 11,8 und 13,5 mm Durchmesser und 40 ovalen Röhren x 20 x 2 und durch Radankerplatten mit Dicken von 8 mm Schweißverbindungen mit einer durchschnittlichen Durchdringung von 15% bei den Stäben und durch Beiträge bei den übrigen Verbindungen.

BESCHICHTUNGEN

Verzinkung: elektrolytische Verzinkung mit einer Beschichtung von 10 bis 25 Mikrometer dicker
Transparent Polyester-Lack-Schutz von 90 bis 100 Mikrometer bei 200 ° C polymerisiert.

KOMFORT, ERGONOMIE, SICHERHEIT UND RFID TECHNOLOGIE

Alle Einkaufswagen erfüllen alle Anforderungen in Bezug auf Ergonomie, Komfort und Sicherheit, gemäß den Normen UNE-EN 1929-1 / UNE-EN 1929-2 / UNE-EN 1929-3 / UNE-EN 1929-4 / UNE-EN 1929-7.

Einkaufswagen zur automatischen Identifizierung und Abrechnung über das elektronische Etikettiersystem.

Kompatibel mit RFID (Radio Frequency Identification)

*Ausstehenden Zertifikat



TODAS LAS RUEDAS DE NUESTROS PRODUCTOS ESTAN APROBADAS Y HOMOLOGADAS SEGÚN NORMA C.E.N. N-1049

ALLE ROLLEN UNSERER PRODUKTEN SIND NACH DEN C.E.N. N-1049 NORM GENEHMIGT UND HOMOLOGISIERT.



2 - Ø100

Rueda giratoria, soporte de chapa de acero, zincadas, rodamiento giratorio de dos hileras de bolas, agujero pasante. Núcleo de la rueda de polipropileno. Bandaje: Goma maciza de color gris que no deja huella, cojinete de bolas a precisión.

Datos técnicos :
Diámetro de la rueda 100 mm - Ancho de la rueda 32 mm - Agujero pasante 13 mm - Desplazamiento 35 mm,
Interferencia de giro 170 mm - Altura total 129 mm - Temperatura - 20 / + 60 °C - Normal EN 12530 - Peso de la rueda 0.58 kg
Radio giratorio 85 mm - Dureza del bandaje Shore A 75 - Capacidad de carga 80 kg - Capacidad de carga estática 160kg .

Lenkrolle, Gehäuse aus Stahlblech, glanzverzinkt, blaupassiviert, Schwenklager mit zweifachem Kugelkranz, Radachse verschraubt, Anschraubloch. Radkörper aus Polypropylen, Lauffläche aus Vollgummi, grau-spurlos, Präzisionskugellager.

Technische Daten :
Rad-Ø 100 mm - Radbreite 32 mm - Rückenloch 13 mm - Ausladung 35 mm - Störkreis-Ø 170 mm - Bauhöhe 129 mm,
Temperaturbereich - 20 / + 60 °C - Norm EN 12530 - Eigengewicht 0.58 kg - Störkreisradius 85 mm,
Härte der Lauffläche Shore A 75 - Tragfähigkeit 80 kg - Tragfähigkeit (statisch) 160 kg .



3 - Ø125

Rueda giratoria, soporte de chapa de acero, zincadas, rodamiento giratorio de dos hileras de bolas, agujero pasante. Núcleo de la rueda de polipropileno. Bandaje: Goma maciza de color gris que no deja huella, cojinete de bolas a precisión.

Datos técnicos :
Diámetro de la rueda 125 mm - Ancho de la rueda 32 mm - Agujero pasante 13 mm - Desplazamiento 38 mm,
Interferencia de giro 201 mm - Altura total 155 mm - Temperatura - 20 / + 60 °C - Normal EN 12530 - Peso de la rueda 0.777 kg
Radio giratorio 100.5 mm - Dureza del bandaje Shore A 75 - Capacidad de carga 80 kg - Capacidad de carga estática 160 kg .

Lenkrolle, Gehäuse aus Stahlblech, glanzverzinkt, blaupassiviert, Schwenklager mit zweifachem Kugelkranz, Radachse verschraubt, Anschraubloch. Radkörper aus Polypropylen, Lauffläche aus Vollgummi, grau-spurlos, Präzisionskugellager.

Technische Daten :
Rad-Ø 125 mm - Radbreite 32 mm - Rückenloch 13 mm - Ausladung 38 mm - Störkreis-Ø 201 mm - Bauhöhe 155 mm
Temperaturbereich - 20 / + 60 °C - Norm EN 12530 - Eigengewicht 0.777 kg - Störkreisradius 100.5 mm,
Härte der Lauffläche Shore A 75 - Tragfähigkeit 80 kg - Tragfähigkeit (statisch) 160 kg .



8 - Ø125

Ruedas de rampa con patas de freno integradas, anti-hilos con patas de freno integradas., Soporte de chapa de acero, zincadas, rodamiento giratorio de dos hileras de bolas, Núcleo de rueda de poliuretano, bandaje de poliuretano, 4 ranuras, autolimpiante entre las ranuras, con placas anti-hilos, cojinetes de bolas de precisión, distancia entre las ranuras: aprox. 4,5 mm, ancho de la ranura: 4 mm . Diseñado para funcionar en las siguientes medidas de rampa: ancho de ranuras: aprox.: 2,75 mm, distancia entre las ranuras: aprox.5,7 mm, profundidad de las ranuras: > 10 mm.

Sugerencia:
Capacidad de carga 80 kg por rueda en pavimentos lisos, 40 kg por rueda en rampas. Por favor tenga en cuenta que según EN1929 sólo las ruedas con un diámetro mínimo de 120 mm puede ser usadas en rampas.

Datos técnicos :
Diámetro de la rueda 125 mm - Ancho de la rueda 32 mm - Agujero pasante 13 mm - Desplazamiento 40 mm -
Interferencia de giro 205 mm - Altura total 153 mm - Temperatura - 40 / + 60 °C - Normal EN 12530 - Peso de la rueda 0.731 kg
Radio giratorio 102.5 mm, - Dureza del bandaje Shore D 59 - Capacidad de carga 80 kg - Capacidad de carga estática 160 kg.

Fahrsteigrolle mit seitlichem Bremssteg für Fahrsteige mit Paletten. Beidseitiger Fadenschutz mit integriertem Bremsfuß (Aufsetzfunktion),Gehäuse aus Stahlblech, glanzverzinkt, blaupassiviert, Schwenklager mit zweifachem Kugelkranz, Radachse verschraubt, Radkörper aus Polyurethan, Lauffläche aus Polyurethan, 4 Laufringe, Selbstreinigungsfunktion zwischen den Laufingen, mit Fadenschutz, Präzisionskugellager, Abstand zwischen den Laufingen: ca. 4,5 mm, Laufingbreite: ca. 4,0 mm. Abgestimmt auf die Palettenmaße: Stegbreite: ca. 2,75 mm, Nutbreite ca. 5,7 mm, Nuttiefe > 10 mm.

Hinweis:
Tragfähigkeit 80 kg pro Rolle auf ebenen und befestigten Böden, 40 kg pro.Rolle auf Fahrsteigen. Bitte beachten Sie, dass nach EN1929 auf Fahrsteigen nur Rollen mit einem Raddurchmesser von mindestens 120 mm eingesetzt werden dürfen.

Technische Daten :
Rad-Ø 125 mm - Radbreite 32 mm - Rückenloch 13 mm - Ausladung 40 mm - Störkreis-Ø 205 mm - Bauhöhe 153 mm,
Temperaturbereich - 40 / + 60 °C - Norm EN 12530 - Eigengewicht 0.731 kg - Störkreisradius 102.5 mm,
Härte der Lauffläche Shore D 59 - Tragfähigkeit 80 kg - Tragfähigkeit (statisch) 160 kg .

MANGO GRIFFE
ERGOBOX



Nuestro mango ERGOBOX, de gran robustez, ha sido el resultado de un minucioso estudio de ergonomía, consiguiendo con el diseño de su empuñadura un manejo mucho más cómodo del carro. Ofrece un gran espacio para publicidad o para su marca. Con posibilidad de un monedero integrado.

Unser Griff ERGOBOX ist das Ergebnis einer eingehenden Studie über Ergonomie. Dieser Griff ist viel bequemer für die Kunden mit integrierter Münzpfandsystem. Es bietet größeren Raum für Werbung oder für Ihre Marke.

PORTA-SCANNER
SCANNER-HALTERUNG

LUPA PLEGABLE
KLAPPBARER LUMPENGLAS



Porta-scanner preparado para (Motorola o Metrologic). Lupa plegable para facilitar la difícil lectura de difícil visión de algunos productos. Dos de los accesorios más útiles para conseguir el mango más completo del mercado.

Scanner-Halterung startbereit für (Motorola oder Metrologic). Lumenglas zum Erleichtern des Ablesens von Sehschwierigkeiten einiger Produkte. Zwei der nützlichsten Zubehörteile, um den umfassendsten Griff auf dem Markt zu erhalten

SOPORTE SCANNER INDIVIDUAL
EINZEL SCANNER HALTERUNG



Sencillo soporte de scanner (Motorola-Metrologic) tanto para mango redondo como para mango ERGOGRIP.

Einfache Scanner-Halterung (Motorola-Metrologic), sowohl für Rundgriff als auch für Ergogrip-Griff.

SOPORTE VASOS
BECHERHALTER



Completamente integrado y concebido para el mango ERGOBOX, admite todo tipo de vasos.

Voll integriert und für den ERGOBOX-Griff konzipiert, zulässt es alle Arten von Becher.

PROMOBOX



La manera más eficaz de darle mayor espacio publicitario. Válido tanto para el mango Ergogrip (oval) como para el redondo.

Der effizienteste Art, mehr Werbefläche zu haben, sowohl für den Ergogrip (oval) als auch für den Rundgriffe.

MANGO REDONDO Y MANGO OVAL (ERGOGRIP)
ERGOGRIP GRIFF (OVAL) UND RUNDROHRGRIFF (STANDARD)



Opciones sencillas y cómodas para el manejo de carro.

Einfache und bequeme Optionen für die Handhabung des Einkaufswagen.

CONJUNTOS DE MANGOS PLUS
GESAMTHEIT PLUS-GRIFF



ERGOBOX PLUS

ERGOGRIP PLUS

REDONDO PLUS

Agarre vertical ergonómico "PLUS" para facilitar el manejo del carro. Adaptable a mango ERGOBOX, ERGOGRIP y REDONDO.

Einfache Scanner-Halterung (Motorola-Metrologic), sowohl für Rundgriff als auch für Ergogrip-Griff.

MANGO RELAXT
ERGOBOX WITHOUT LOCK



Solución adaptada para los modelos de carros Multigrip de 80 y 98 L. Diseño ergonómico y vanguardista, con monedero integrado, manteniendo el espacio promocional.

Lösung für unsere 80 UND 98L Multigrip-Einkaufswagen mit ergonomischem, innovativem und avantgardistischem Design. Mit integriertem Münzpfandsystem. Es bietet eine große Werbefläche.

ERGOBOX SIN MONEDERO
ERGOBOX GRIFF OHNE MÜNZPFANDSYSTEM



Para mayor espacio publicitario. Für mehr Werbefläche.

MONEDEROS
SMARLOC



Material de alta calidad
Hochwertiger Material.

MÜNZPFANDSYSTEME
VARILOC



Acabado metálico
Stahlbau endverarbeitung.

MONEDERO Y TAPA LATERAL MULTIGRIP
MÜNZPFANDSYSTEM UND SEITLICHE MULTIGRIP-ABDECKUNG

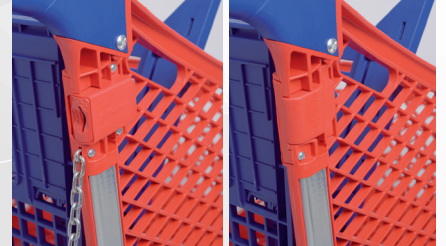

Nuestros modelos de carros Multigrip disponen de opción de monedero lateral o tapa lateral en ausencia del mismo.

Unsere Modelle von Multigrip-Einkaufswagen haben die Option einer Münzpfandsystem oder einer Seitenverkleidung, sofern diese nicht vorhanden ist.

SEPARADOR DE CESTO
QUERTRENNGITTER



Complemento del cesto que permite tanto la ubicación de productos embolsados como de elementos más delicados.

Ergänzung des Korbs, der sowohl die Platzierung von verpackten Produkten als auch von empfindlicheren Elementen ermöglicht.

PORTACARTEL PUBLICITARIO
PLAKATRAHMEN



Una forma inteligente de incrementar la rentabilidad de su carro, así como un método muy directo de impacto publicitario.

Eine Clevere Möglichkeit, um die Rentabilität des Einkaufswagen zu erhöhen, und die Aufmerksamkeit der Kunden zu lenken.

CESTO SOPORTE CUNA
BABY SCHALENKORB



Perfecto complemento para adaptar la cuna personal del cliente.

Perfekte Ergänzung, anpassbar an jedes Kunden Babyschale

CUNA PARA CARRO
BABYSCHALE



El diseño así como los materiales empleados, hace de la cuna el asiento ideal para el bebé, sin llegar a restar capacidad de carga al carro.

Ausgezeichnete Qualität der Babyschale für den Komfort Ihres Babys. Die Korbkapazität ändert sich nicht

PORTA-BEBE DOBLE FUNCION
KINDERSITZ - WARENABLAGE



Gracias a la tapa inferior del asiento, permite una carga adicional de producto, ideal para productos delicados.

Dank der unteren Abdeckung des Sitzes ermöglicht eine zusätzliche Gebühr von Produkt, ideal für empfindliche Produkte.

BANDERA DE LOCALIZACION
STANDORTFLAGE



Complemento ideal para la localización de los carros.

Perfekte Ergänzung für den Standort der Einkaufswagen.

RACK BOTELLERO PLEGABLE
AUSGEKLAHPTE KISTENABLAGE



Fácil de abatir, es el mejor accesorio para transportar las cajas de líquidos o packs.

Einfach zusammenzuklappen, es ist das beste Zubehör Geeignet für Getränkeboxen oder Waschmittelkartonen.

RACK BOTELLERO FIJO DELANTERO
VORNE FESTER KISTENABLAGE



Solución para el transporte de packs en los carros Multigrip 100, 98 y 80 L, y en los carros Polysteel de 90 y 110 L.

Lösung für den Transport von Flaschengestellen in Multigrip 100, 98, 80L und Polysteel-Ekw 90 und 110L.

REJILLA PLATAFORMA
DRAHTPLATTFORM



Aprovechamiento del espacio de carga en la plataforma standard. La inclinación de la parrilla facilita la fijación del producto y su uso en rampas mecánicas.

Zusätzliche Ladekapazität für die Standardlinie-Einkaufswagen. Mit der Inklination der Drahtplattform schieben sich die Einkaufswagen perfekt ineinander. Gleichzeitig ermöglicht dies den Einsatz in Fahrsteigen.

GAMA DE COLORES
FARBBEREICH



RAL 5002	AZUL ULTRAMARINO	ULTRAMARINBLAU
RAL 3000	ROJO FUEGO	FEUERROT
RAL 6029	VERDE MENTA	MINTGRÜN
RAL 7015	GRIS PIZARRA	SCHIEFERGRAU
RAL 1018	AMARILLO ZINC	ZINK GELB
* RAL 2003	NARANJA	ORANGE
* RAL 9005	NEGRO	SCHWARZ

* colores standard sólo disponibles para carro multigrip 100L (otros modelos bajo consulta)

* Standardfarben nur für Multigrip 100L erhältlich (andere Modelle auf Anfrage)

POLYSTEEL



GAMA STANDARD STANDARDSORTIMENT

P O L Y S T E E L 2 4 2 S T D



Ø125



CPSDF24203
22,6kg.

Ø125



CPSDF24208
22,6 kg.

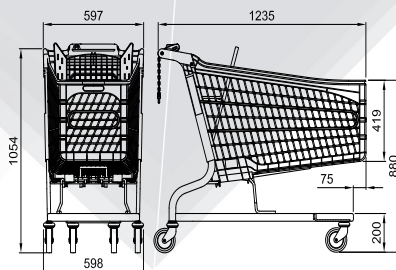

PARKING

- X 5 2,255 mts.
- x 10 3,530 mts.
- x 15 4,805 mts.
- x 25 7,355 mts.





Ø125



3

CPSDF22003
21,1 kg

Ø125



8

CPSDF22008
21,1 kg.

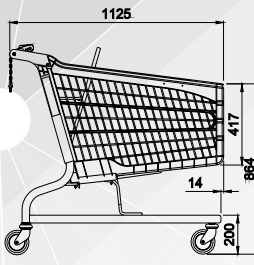
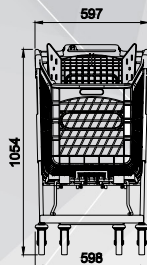

PARKING

- X 5 2,145 mts.
- x 10 3,420 mts.
- x 15 4,695 mts.
- x 25 7,245 mts.

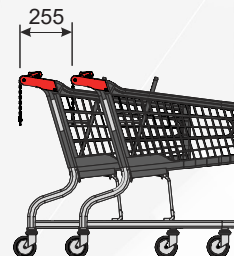

Ø125



3

CPSDF19503
19,7 kg.

Ø125



8

CPSDF19508
19,7 kg.

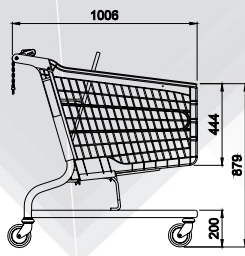
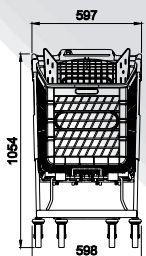

PARKING

- X 5 2,026 mts.
- x 10 3,301 mts.
- x 15 4,576 mts.
- x 25 7,126 mts.

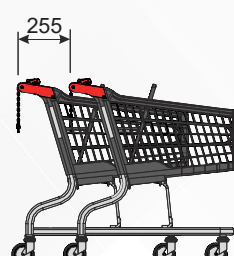



Ø125



3

Ø125



8

CPGDF16003-RP
21,3 kg.

CPGDF16008-RP
21,3 kg.

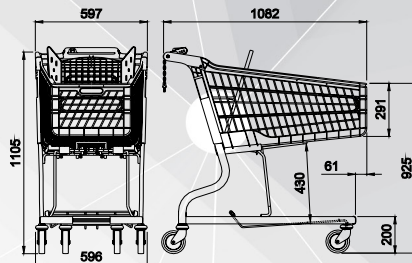

PARKING

- X 5 2,102 mts.
- x 10 3,377 mts.
- x 15 4,652 mts.
- x 25 7,202 mts.



Ø125



Ø125



CPGDF14003-RP
20,2 kg.

CPGDF14008-RP
20,2 kg.

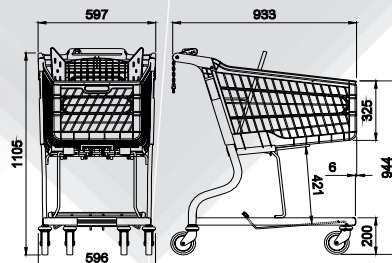

PARKING

- X 5 1,953 mts.
- x 10 3,228 mts.
- x 15 4,503 mts.
- x 25 7,053 mts.

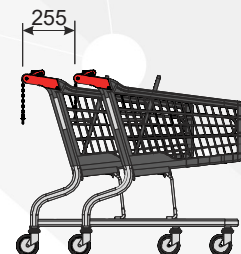



Ø125



CPSDF16003
18,9 kg.

Ø125



CPSDF16008
18,9 kg.

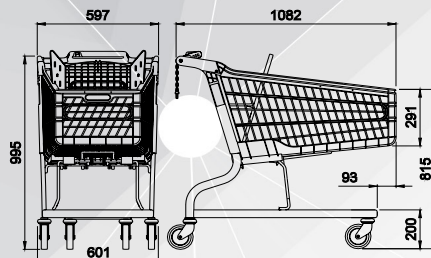

PARKING

X 5	2,102 mts.
x 10	3,377 mts.
x 15	4,652 mts.
x 25	7,202 mts.

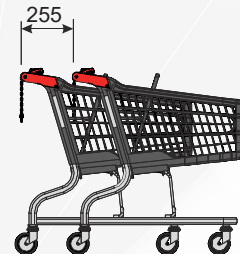

POLYSTEEL 140 STD



Ø125



CPSDF14003
18,1 kg.

Ø125



CPSDF14008
18,1 kg.

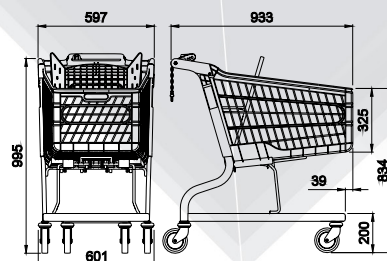

PARKING

X 5	1,953 mts.
x 10	3,228 mts.
x 15	4,503 mts.
x 25	7,053 mts.

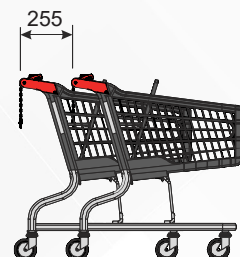



Ø125



CPSSP11003
17,5 kg.

Ø125



CPSSP11008
17,5 kg.

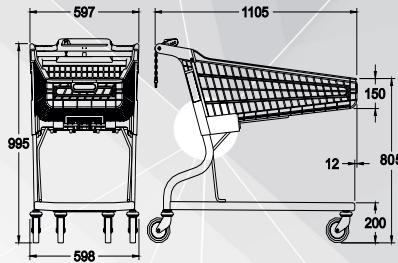

PARKING

- X 5 2,025 mts.
- x 10 3,174 mts.
- x 15 4,325 mts.
- x 25 6,625 mts.



POLYSTEEL 90 STD



Ø125



CPSSP09003
15,8 kg.

Ø125



CPSSP09006
15,8 kg.

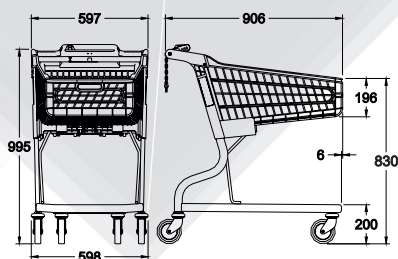

PARKING

- X 5 1,826 mts.
- x 10 2,976 mts.
- x 15 4,126 mts.
- x 25 6,426 mts.



ACCESORIOS GAMA STANDARD

ZUBEHÖR STANDARD LINIE

EN OPCIÓN OPTIONAL	90	110	140	140 GC	160	160 GC	195	220	242
DE SERIE STANDARD									
MANGO ERGOBOX ERGOBOX GRIFF CMEBPS									
MANGO ERGOGRIP - FG ERGOGRIP - FG GRIFF CMEFGPS									
MANGO REDONDO RUNDROHRGRIFF CMRPS									
MANGO ERGOBOX PLUS ERGOBOX PLUS GRIFF CMEBPSP									
MANGO ERGOGRIP - FG PLUS ERGOGRIP - FG PLUS GRIFF CMEFGPSP									
MANGO REDONDO PLUS RUNDROHRGRIFF PLUS CMRPSP									
SOPORTE SCANNER ERGOBOX SCANNERHALTERUNG ERGOBOX SSE									
SOPORTE SCANNER MANGO ERGOGRIP - FG SCANNERHALTERUNG ERGOGRIP - FG GRIFF SSIND									
SOPORTE SCANNER MANGO REDONDO SCANNERHALTERUNG RUNDROHRGRIFF SSINDT									
PROMOBBOX MANGO ERGOGRIP - FG PROMOBBOX ERGOGRIP GRIFF PMSEFG									
PROMOBBOX MANGO REDONDO PROMOBBOX RUNDROHRGRIFF PMR									
SOPORTE VASOS MANGO ERGOBOX GETRÄNKEHALTER ERGOBOX GRIFF SVMEBX									
LUPA PLEGABLE MANGO ERGOBOX KLAPPBARE LUPENGLAS ERGOBOX GRIFF LPMEBX									
PORTABEBÉ DOBLE FUNCIÓN KINDERSTZ- WARENABLAG 9011RBDFPS (90-110 METÁLICO) (METALLIC) CBAPBPS1416 (140-160) - CBAPBPS1920 (195-220-242)									
REJILLA TRASERA SIN PORTABEBE RÜCKGITTER OHNE KINDERSTZ RTPS9011 (90-110)									
RACK BOTELLERO STARRE KISTENABLAG RBPFP9011 (90-110) - RBPS (140-160-195-220-242)									
REJILLA PLATAFORMA DRAHTPLATTFORM RPPS90 (90) - RPPS110 (110) - RPLPS (140) RGLPS (160-195) - RPLPS220 (220)									
REJILLA PLATAFORMA CORTA (CON BOTELLERO) KURZE DRAHTPLATTFORM RPCPS (140) - RGCP (160-195) - RPCPS220 (220)									
SEPARADOR DE PRODUCTOS QUERTRENNGITTER SPS14 (140) - SPS16 (160) - SPS19 (195) SPS22 (220) - SPS24 (240)									
BANDERA DE LOCALIZACIÓN FAHNENMAST MBCP									
CUNA DE CESTO BABYSCHALE CCBD									
CESTO SOPORTE CUNA BABY SCHALENKORB CSCP									
PORTACARTELES PUBLICITARIO ADVERTISEMENT HOLDER PCPCP									

POLYSTEEL



**GAMA ANTIHURTO
DIEBSTAHLSCHUTZSORTIMENT**

P O L Y S T E E L 2 4 2 A T H



Ø125



CPADF24203
22,7 kg.

Ø125



CPADF24208
22,7 kg.

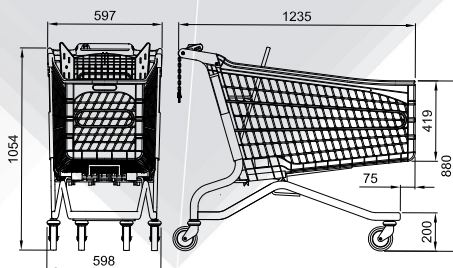

PARKING

- X 5 2,255 mts.
- x 10 3,530 mts.
- x 15 4,805 mts.
- x 25 7,355 mts.





Ø125



CPADF22003
21,2 kg.

Ø125



CPADF22008
21,2 kg.

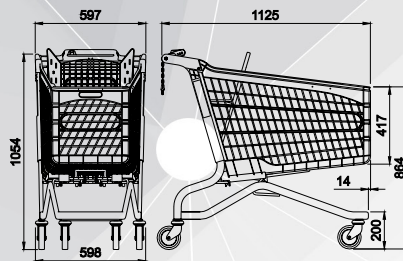

PARKING

- X 5 2,145 mts.
- x 10 3,420 mts.
- x 15 4,695 mts.
- x 25 7,245 mts.



P O L Y S T E E L 1 9 5 A T H



Ø125



CPADF19503
19,5 kg.

Ø125



CPADF19508
19,5 kg.

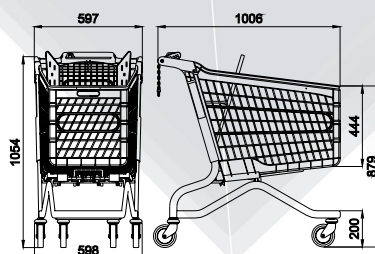

PARKING

- X 5 2,026 mts.
- x 10 3,301 mts.
- x 15 4,576 mts.
- x 25 7,126 mts.





Ø125



CPADF16003
18,9 kg.

Ø125



CPADF16008
18,9 kg.

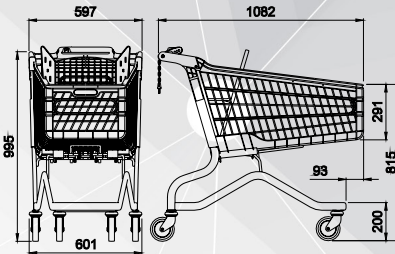

PARKING

- X 5 2,102 mts.
- x 10 3,377 mts.
- x 15 4,652 mts.
- x 25 7,202 mts.



POLYSTEEL 140ATH



Ø125



CPADF14003
18,2 kg.

Ø125



CPADF14008
18,2 kg.

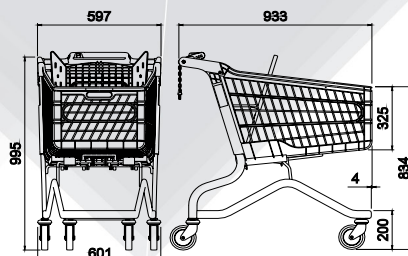

PARKING

- X 5 1,953 mts.
- x 10 3,228 mts.
- x 15 4,503 mts.
- x 25 7,053 mts.

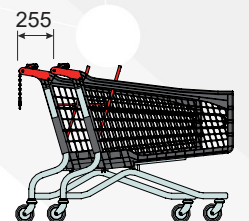



Ø125



CPASP11003
16,4 kg.

Ø125



CPASP11008
16,4 kg.

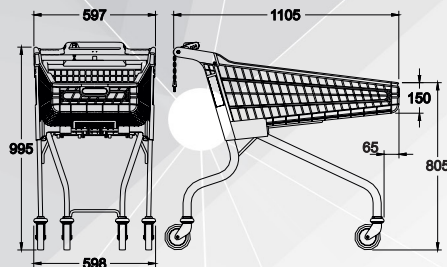

PARKING

- X 5 2,025 mts.
- x 10 3,174 mts.
- x 15 4,325 mts.
- x 25 6,625 mts.

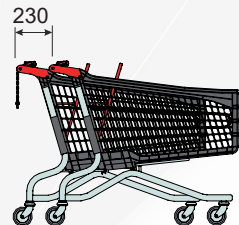

* POLYSTEEL 90ATH



Ø125



CPASP09003
14,9 kg.

Ø125



CPASP09008
14,9 kg.

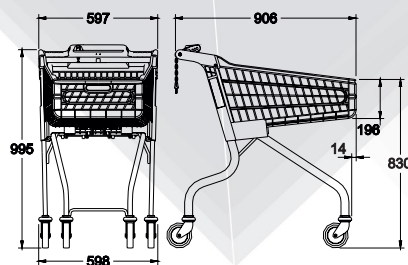

PARKING

- X 5 1,826 mts.
- x 10 2,976 mts.
- x 15 4,126 mts.
- x 25 6,426 mts.



ACCESORIOS GAMA ANTIHURTO

ZUBEHÖR DIEBSTAHLSCHUTZ LINIE

EN OPCIÓN  OPTIONAL 	90	110	140	160	195	220	242
DE SERIE  STANDARD 							
 MANGO ERGOBOX ERGOBOX GRIFF CMEBPS							
 MANGO ERGOGRIP - FG ERGOGRIP - FG GRIFF CMEFGPS							
 MANGO REDONDO RUNDROHRGRIFF CMRPS							
 MANGO ERGOBOX PLUS ERGOBOX PLUS GRIFF CMEBPS							
 MANGO ERGOGRIP - FG PLUS ERGOGRIP - FG PLUS GRIFF CMEFGPS							
 MANGO REDONDO PLUS RUNDROHRGRIFF PLUS CMRPS							
 SOPORTE SCANNER ERGOBOX SCANNERHALTERUNG ERGOBOX SSE							
 SOPORTE SCANNER MANGO ERGOGRIP - FG SCANNERHALTERUNG ERGOGRIP - FG GRIFF SSIND							
 SOPORTE SCANNER MANGO REDONDO SCANNERHALTERUNG RUNDROHRGRIFF SSINDT							
 PROMOBOX MANGO ERGOGRIP - FG PROMOBOX ERGOGRIP GRIFF PMSEFG							
 PROMOBOX MANGO REDONDO PROMOBOX RUNDROHRGRIFF PMR							
 SOPORTE VASOS MANGO ERGOBOX GETRÄNKEHALTER ERGOBOX GRIFF SVMEBX							
 LUPA PLEGABLE MANGO ERGOBOX KLAPPBARE LUPENGLAS ERGOBOX GRIFF LPMEBX							
 PORTABEBÉ DOBLE FUNCIÓN KINDERSITZ- WARENABLAGE 9011RBDFPS (90-110 METÁLICO) (METALLIC) CBAPBPS1416 (140-160) - CBAPBPS1920 (195-220-242)							
 REJILA TRASERA SIN PORTABEBÉ RÜCKGITTER OHNE KINDERSITZ RTPS9011 (90-110)							
 RACK BOTELLERO STARRE KISTENABLAGE RBPS (140-160) - RBPAP (195-220-42)							
 RACK BOTELLERO DELANTERO VORDERE STARRE KISTENABLAGE RBFDPAP90 (90) - RBFDPAP110 (110)							
 SEPARADOR DE PRODUCTOS QUERTRENNGITTER SPS14 (140) - SPS16 (160) - SPS19 (195) SPS22 (220) - SPS24 (240)							
 BANDERA DE LOCALIZACIÓN FAHNENMAST MBCP							
 CUNA DE CESTO BABYSCHALE CCBD							
 CESTO SOPORTE CUNA BABY SCHALENKORB CSCP							
 PORTACARTELES PUBLICITARIO ADVERTISEMENT HOLDER PCPCP							



Ø125



CPGSP11003
22,9 kg.

Ø125



CPGSP11008
22,9 kg.

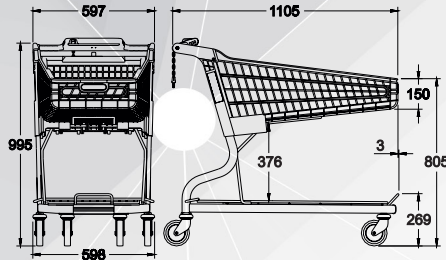

PARKING

- X 5 2,025 mts.
- x 10 3,174 mts.
- x 15 4,325 mts.
- x 25 6,625 mts.



Ø125



CPBSP11003
25,7 kg.

Ø125



CPBSP11008
25,7 kg.

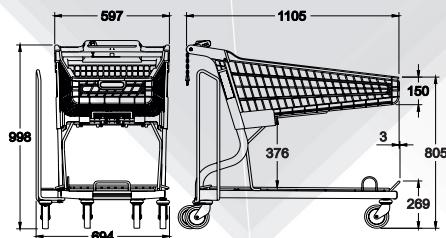

PARKING

- X 5 2,025 mts.
- x 10 3,174 mts.
- x 15 4,325 mts.
- x 25 6,625 mts.





Ø125



CPGSP09003
20,4 kg.

Ø125



CPGSP09008
20,4 kg.

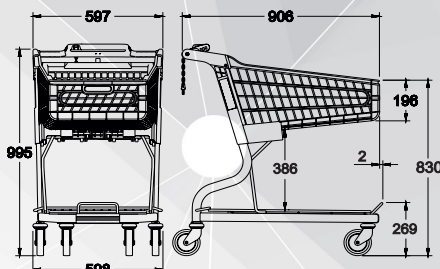

PARKING

- X 5 1,826 mts.
- x 10 2,976 mts.
- x 15 4,126 mts.
- x 25 6,426 mts.

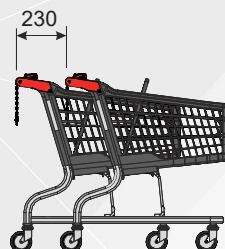

Ø125



CPGGSP9003
22 kg.

Ø125



CPGGSP9008
22 kg.

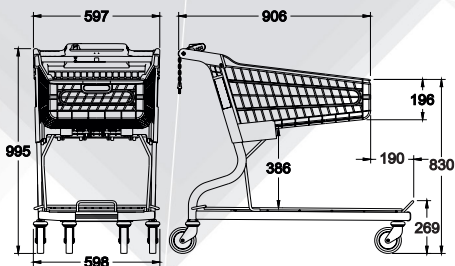

PARKING

- X 5 2,016 mts.
- x 10 3,166 mts.
- x 15 4,316 mts.
- x 25 6,616 mts.

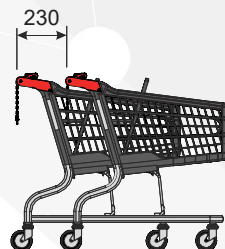



Ø125



CPBSP09003
23,1 kg.

Ø125



CPBSP09008
23,1 kg

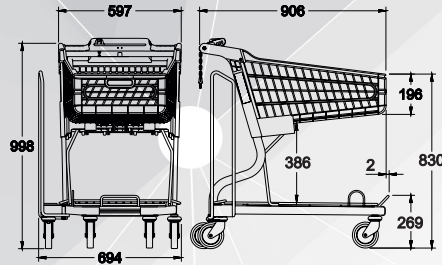

PARKING

- X 5 1,826 mts.
- x 10 2,976 mts.
- x 15 4,126 mts.
- x 25 6,426 mts.

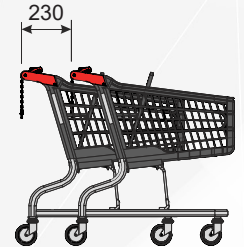

Ø125



CPBGSP9003
24,7 kg.

Ø125



CPBGSP9008
24,7 kg.

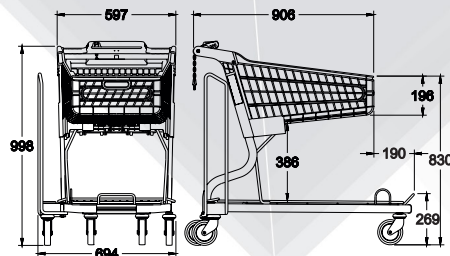

PARKING

- X 5 2,016 mts.
- x 10 3,166 mts.
- x 15 4,316 mts.
- x 25 6,616 mts.

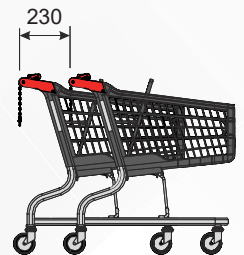

ACCESORIOS GAMA "BGA"

ZUBEHÖR "BGA" LINIE

EN OPCIÓN  OPTIONAL 		90TG	90TG GC	90TB	90TB GC	110TG	110TB
DE SERIE  STANDARD 							
	MANGO ERGOBOX ERGOBOX GRIFF CMEBPS						
	MANGO ERGOGRIP - FG ERGOGRIP - FG GRIFF CMEFGPS						
	MANGO REDONDO RUNDROHRGRIFF CMRPS						
	MANGO ERGOBOX PLUS ERGOBOX PLUS GRIFF CMEBPSP						
	MANGO ERGOGRIP - FG PLUS ERGOGRIP - FG PLUS GRIFF CMEFGPSP						
	MANGO REDONDO PLUS RUNDROHRGRIFF PLUS CMRPS						
	SOPORTE SCANNER ERGOBOX SCANNERHALTERUNG ERGOBOX SSE						
	SOPORTE SCANNER MANGO ERGOGRIP - FG SCANNERHALTERUNG ERGOGRIP - FG GRIFF SSIND						
	SOPORTE SCANNER MANGO REDONDO SCANNERHALTERUNG RUNDROHRGRIFF SSINDT						
	PROMOBOX MANGO ERGOGRIP - FG PROMOBOX ERGOGRIP GRIFF PMSEFG						
	PROMOBOX MANGO REDONDO PROMOBOX RUNDROHRGRIFF PMR						
	SOPORTE VASOS MANGO ERGOBOX GETRÄNKEHALTER ERGOBOX GRIFF SVMEBX						
	LUPA PLEGABLE MANGO ERGOBOX KLAPPBARE LUPENGLAS ERGOBOX GRIFF LPMEBX						
	PORTABEBÉ DOBLE FUNCIÓN KINDERSITZ- WARENABLAGE 9011RBDFPS (90-110 METÁLICO) (METALLIC)						
	REJILA TRASERA SIN PORTABEBE RÜCKGITTER OHNE KINDERSITZ RTPS9011 (90-110)						
	BANDEJA INFERIOR TECNO-GARDEN TRAY BASE FÜR TECHNO-GARDEN 90TGP2 (90) - 110TGP2 (110)						
	BANDEJA INFERIOR TECNO-BRICOLAJE TRAY BASE FÜR TECHNO-D.I.Y. 90TBP2 (90) - 110TBP2 (110)						
	PORTATABLEROS PLATTENROLLER PTTO3						
	BANDERA DE LOCALIZACIÓN FAHNENMAST MBCP						
	CUNA DE CESTO BABYSCHALE CCBD						
	CESTO SOPORTE CUNA BABY SCHALENKORB CSCP						



MULTIGRIP

MULTIGRIP 150 GRAN CARGA - GROSSE BELASTUNG



Ø125



CPMGDF1503-RP
21,3 KG

Ø125



CPMGDF1508-RP
21,3 KG

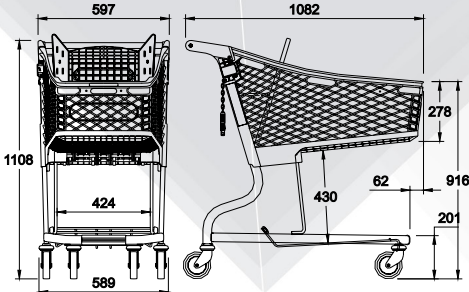

PARKING

- X 5 2,082 mts.
- x 10 3,332 mts.
- x 15 4,582 mts.
- x 25 7,082 mts.

250 mm.





Ø125



CPMSDF1503
19,5 KG.

Ø125



CPMSDF1508
19,5 KG.

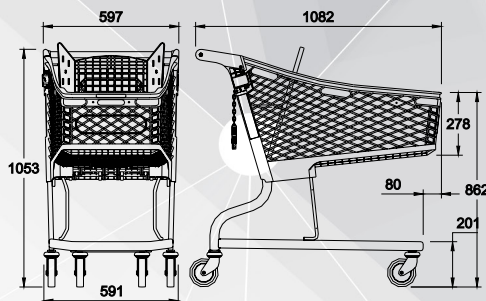

PARKING

- X 5 2,082 mts.
- x 10 3,332 mts.
- x 15 4,582 mts.
- x 25 7,082 mts.

250 mm.



Ø125



CPMSDF1303
18,9 KG.

Ø125



CPMSDF1308
18,9 KG.

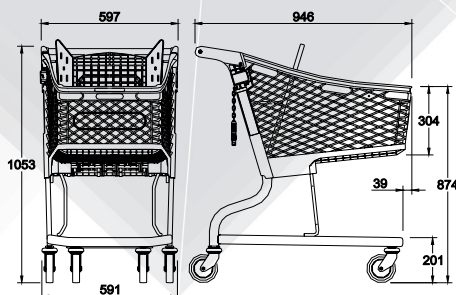

PARKING

- X 5 1,946 mts.
- x 10 3,196 mts.
- x 15 4,446 mts.
- x 25 6,946 mts.

250 mm.





Ø125



CPMADF1503
18,3 KG.

Ø125



CPMADF1508
18,3 KG.

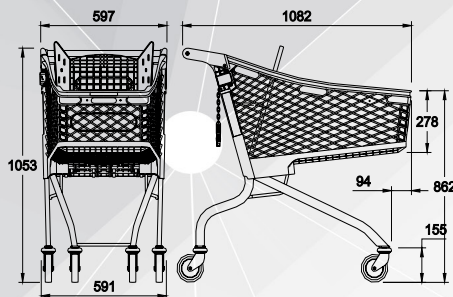

PARKING

X 5	2,082 mts.
x 10	3,332 mts.
x 15	4,582 mts.
x 25	7,082 mts.

250 mm.



Ø125



CPMADF1303
17,7 KG.

Ø125



CPMADF1308
17,7 KG.

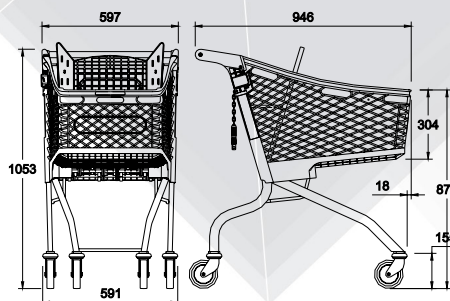

PARKING

X 5	1,946 mts.
x 10	3,196 mts.
x 15	4,446 mts.
x 25	6,946 mts.

250 mm.





Ø100



CPMASP1002B-RB
13,4 KG.

Ø100



CPMASP1002B
12,5 KG

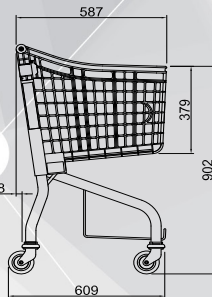
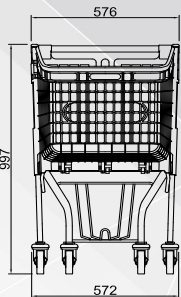

PARKING

- X 5 1,087 mts.
- X 10 1,712 mts.
- X 15 2,337 mts.
- X 25 3,587 mts.

125 mm.

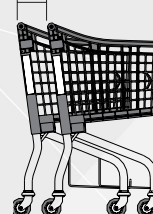

Ø125



CPMASP1008-RB
14,1 KG

Ø125



CPMASP1008
13,4 KG

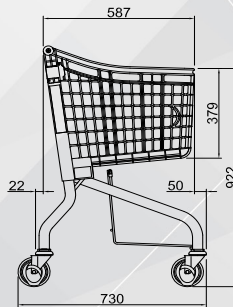
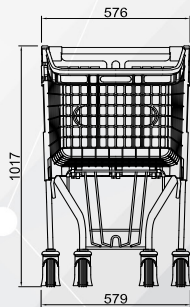

PARKING

- X 5 1,417 mts.
- X 10 2,392 mts.
- X 15 3,367 mts.
- X 25 5,317 mts.

195 mm.

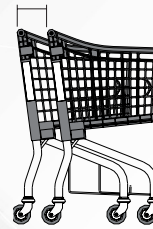



Ø100



CPMADF9802
15,2 KG.

Ø125



CPMADF9808
16 KG.

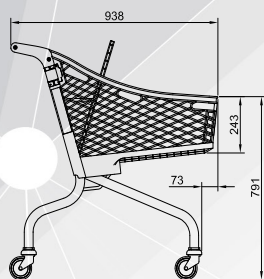
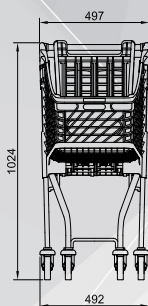

PARKING

- X 5 1,818 mts.
- x 10 2,918 mts.
- x 15 4,018 mts.
- x 25 6,218 mts.



* MULTIGRIP 8 0 ATH



Ø100



CPMADF8002
14,6 KG.

Ø125



CPMADF8008
15,4 KG.

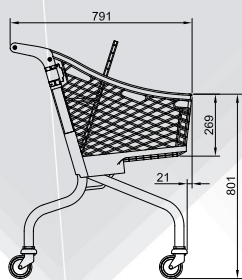
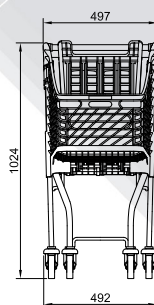



























PARKING

- X 5 1,671 mts.
- x 10 2,771 mts.
- x 15 3,871 mts.
- x 25 6,071 mts.



ACCESORIOS MULTIGRIP

ZUBEHÖR MULTIGRIP

EN OPCIÓN  OPTIONAL 		130 STD	150 STD	150 GC	80 ATH	98 ATH	100 ATH	130 ATH	150 ATH
DE SERIE  STANDARD 									
 MANGO ERGOBOX / MANGO RELAXT (80 - 98) ERGOBOX GRIFF / RELAXT GRIFF (80 - 98) CMEBPS / MRLXT465 (80 - 98)		●	●	●	●	●		●	●
 MANGO ERGOGRIP - FG ERGOGRIP - FG GRIFF CMEFGPS		●	●	●	●	●		●	●
 MANGO REDONDO RUNDROHRGRIFF CMRPS		●	●	●	●	●	●	●	●
 MANGO ERGOBOX PLUS ERGOBOX PLUS GRIFF CMEBSP		●	●	●				●	●
 MANGO ERGOGRIP - FG PLUS ERGOGRIP - FG PLUS GRIFF CMEFGPSP		●	●	●				●	●
 MANGO REDONDO PLUS RUNDROHRGRIFF PLUS CMRPS		●	●	●				●	●
 SOPORTE SCANNER / SOPORTE VASOS ERGOBOX SCANNERHALTERUNG / GETRÄNKEHALTER ERGOBOX SSE / SVMEBX		●	●	●				●	●
 SOPORTE SCANNER MANGO ERGOGRIP - FG SCANNERHALTERUNG ERGOGRIP - FG GRIFF SSIND		●	●	●	●	●		●	●
 SOPORTE SCANNER MANGO REDONDO SCANNERHALTERUNG RUNDROHRGRIFF SSINDT		●	●	●	●	●	●	●	●
 PROMOBX MANGO ERGOGRIP - FG PROMOBX ERGOGRIP GRIFF PMSEFG		●	●	●	●	●		●	●
 PROMOBX MANGO REDONDO PROMOBX RUNDROHRGRIFF PMR		●	●	●	●	●	●	●	●
 LUPA PLEGABLE MANGO ERGOBOX KLAPPBARE LUPENGLAS ERGOBOX GRIFF LPMBX		●		●	●	●		●	●
 PORTABEBÉ DOBLE FUNCIÓN KINDERSITZ- WARENABLAGE CBAPBPS1416 (130-150) - CBAPBPM8098 (80-98)		●	●	●	●	●		●	●
 REJILLA TRASERA SIN PORTABEBÉ RÜCKGITTER OHNE KINDERSITZ RTPSMG8098 (80-98) - RTPSMG100 (100)		●	●	●	●	●	●	●	●
 RACK BOTELLERO DELANTERO VORDERE STARRE KISTENABLAGE RBPAPM100 (100) - RBPAPM100 (100 RAMPA) RBPAPM80 (80) - RBPAPM98 (98)					●	●	●		
 RACK BOTELLERO STARRE KISTENABLAGE RBPS (130-150 STD) - RBPAPM1315 (130-150 ATH)		●	●					●	●
 REJILLA PLATAFORMA DRAHTPLATTFORM RPLPS (130) - RGLPS (150)		●	●	●					
 REJILLA PLATAFORMA CORTA (CON BOTELLERO) KURZE DRAHTPLATTFORM RPCPS (130) - RGCPS (150)		●	●						
 SEPARADOR DE PRODUCTOS QUERTRENNGITTER SPS13 (130) - SPS15 (150)		●	●	●				●	●
 BANDERA DE LOCALIZACIÓN FAHNENMAST MBCP		●	●	●	●	●	●	●	●
 CUNA DE CESTO BABYSCHALE CCBD		●	●	●				●	●
 CESTO SOPORTE CUNA BABY SCHALENKORB CSCP		●	●	●				●	●
 PORTACARTELES PUBLICITARIO ADVERTISEMENT HOLDER PCPCP		●	●	●			●	●	●



El parking y el carro es el primer contacto visual del negocio con el cliente y un gran exponente de su marca. Unos cobijos personalizados refuerzan el impacto de imagen de la tienda con respecto a su entorno. Consultar para realizaciones a medida.



Die Parkboxen sind den ersten Sichtkontakt der Kunden mit Ihrem Geschäft, und verstärken das Image der Läden. Personalisierte Parkboxen, wo Ihre Einkaufswagen geordnet und geschützt sind und Verstärken Sie die Imagewirkung Ihres Geschäfts in Bezug auf die Umgebung. Für maßgeschneiderte Lösungen fragen Sie uns.



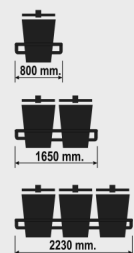
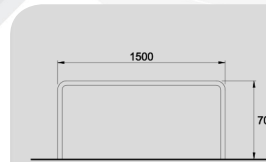
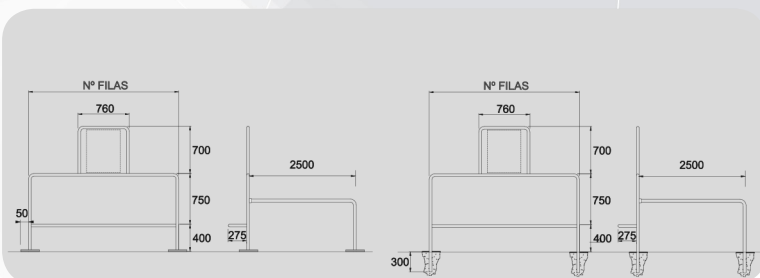
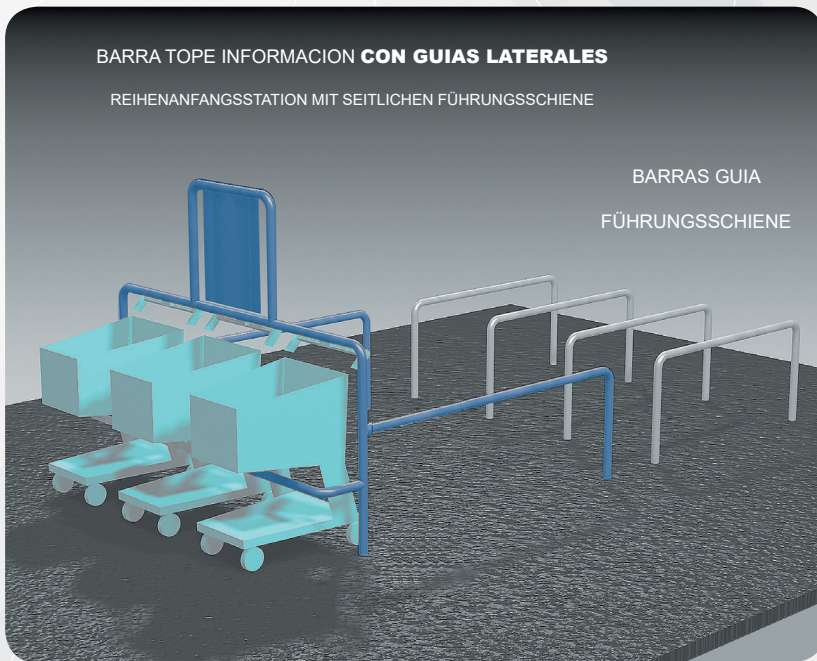
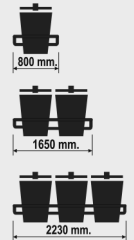
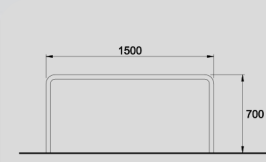
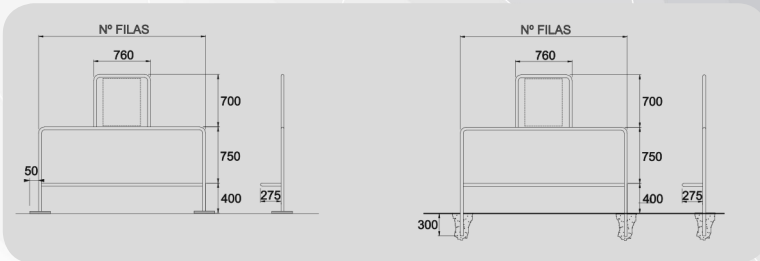
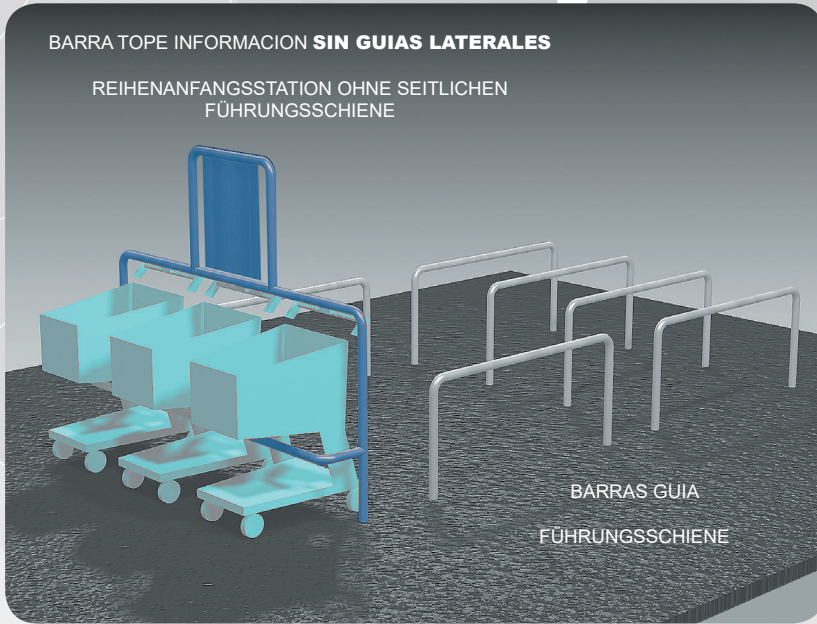

Siempre teniendo presente nuestros valores hacia nuestros clientes

**CALIDAD
INNOVACIÓN
SENTIMIENTO**



Immer unsere Werte vor unseren Kunden zu halten

**QUALITÄT
NEUERUNG
STIMMUNG**



www.marsanz.es



SEDE SOCIAL
HAUPTSITZ

CALLE HIERRO, 27
28850 TORREJON DE ARDOZ
MADRID
ESPAÑA - SPAIN

TEL.: (34) 91 675 14 34 // (34) 91 677 10 92
FAX.: (34) 91 675 12 90
E-MAIL.: creaciones@marsanz.es

PLANTAS DE FABRICACION
HERSTELLUNGSBETRIEB

TORREJON DE ARDOZ (MADRID)
UGENA (TOLEDO)

INTERNACIONAL
INTERNATIONAL

EXPORT DIVISION
E-MAIL.: export@marsanz.es

FRANCIA
FRANKREICH

MARSANZ FRANCE SAS

13 RUE SAINT HONORÉ
78000 VERSAILLES

TEL.: +33 (0) 1 30 88 82 95
E-MAIL.: info@marsanz.fr
www.marsanz.fr

REINO UNIDO
U K

MARSANZ UK Ltd.

46 BEVERLEY ROAD
LEAMINGTON SPA
WARWICKSHIRE CV32 6PJ

PHONE.: +44 (0) 1618818515
E-MAIL.: info@marsanz.co.uk
www.marsanz.co.uk

DISTRIBUIDO POR VERTEILT ÜBER

DELEGACIONES EN ESPAÑA
SPANISCHE FILIALEN

BARCELONA

POLIGONO INDUSTRIAL MOLI D'EN XECH
Calle Barneda, Nº 17 nave 25
Frente Río Ripoll
08291 - RIPOLLET

TEL.: 93 231 34 75
FAX.: 93 231 35 47
E-MAIL.: barcelona@marsanz.es

SEVILLA

AVDA. DEL PARSÍ
POL.IND. MINI PARSÍ, NAVE 9
41016 SEVILLA

TEL.: 95 451 12 45
FAX.: 95 425 85 09
E-MAIL.: andalucia@marsanz.es

ALICANTE

C/ CAMPELLO, 13
POL.IND. LA CALA
03509 FINESTRAT - ALICANTE

TEL.: 96 680 27 04
FAX.: 96 683 07 96
E-MAIL.: levante@marsanz.es

