

POLYSTEEL

1



CHARIOTS MÉTAL

LIBRE SERVICE

METAL

SHOPPING TROLLEYS

Marsanz

FR

EN

CRÉATIVITÉ
INNOVATION

RECHERCHE
RESEARCH

DÉVELOPPEMENT
DEVELOPMENT

QUALITÉ
QUALITY

SERVICE
SERVICE

ÉDITION: AVRIL 2015

EDITION: APRIL 2015

S O M M A I R E

SPÉCIFICATIONS TECHNIQUES DES CHARIOTS	4 - 5
SPÉCIFICATIONS TECHNIQUES DES ROUES	6 - 7
PRÉSENTATION DES CHARIOTS	8 - 9
ACCESSOIRES ET COMPLÉMENTS	10-11
POIGNÉES ET CONSIGNEURS	12-13

CHARIOTS LIBRE SERVICE -GAMME STANDARD-



25L. 50L. 60L.	14
80L. 100L.	15
120L. 140L.	16
150L. 160L.	17
180L. 210L.	18
212L. 240L.	19

CHARIOTS LIBRE SERVICE -GAMME SÉCURITÉ-



80L. 100L.	20
120L. 140L.	21
150L. 160L.	22
180L. 210L.	23
212L. 240L.	24

CHARIOTS LIBRE SERVICE -GAMME SPÉCIALE-



CHARIOT POUR PETITS ACHATS 80L. - 100L.	25
CHARIOT AVEC OUVERTURE FRONTALE RABATTABLE 200L.	26
CHARIOT " T-M " 200L.	26
CHARIOT SKALATOR 120L. - 140L.	27
CHARIOT "EM" 140L.	28
CHARIOT "PMR" 62L.	28
CHARIOT DEUX PANIERS	29
PANIER 25L. - 50 L.	29

ACCESSOIRES

CHARIOTS LIBRE SERVICE "GAMME STANDARD"	30
CHARIOTS LIBRE SERVICE "GAMME SÉCURITÉ"	31
CHARIOTS LIBRE SERVICE "GAMME SPÉCIALE"	32

ABRIS À CHARIOTS // PARC À CHARIOTS	33-34
CERTIFICAT DE CONFORMITÉ	35

ADRESSES	36
----------	----

S U M M A R Y

TROLLEYS' TECHNICAL SPECIFICATIONS	4 - 5
WHEEL' S TECHNICAL SPECIFICATIONS	6 - 7
SHOPPING TROLLEY PRESENTATION	8 - 9
ACCESSORIES AND MISCELLANEOUS	10-11
HANDLES AND COIN DEPOSIT SYSTEM	12-13

SHOPPING TROLLEY -STANDARD LINE-

25L. 50L. 60L.	14
80L. 100L.	15
120L. 140L.	16
150L. 160L.	17
180L. 210L.	18
212L. 240L.	19



SHOPPING TROLLEY - ANTI-THEFT LINE -

80L. 100L.	20
120L. 140L.	21
150L. 160L.	22
180L. 210L.	23
212L. 240L.	24



SHOPPING TROLLEY -SPECIAL LINE-

LIGHT SHOPPING TROLLEY 80L. - 100L.	25
EASY CHECK-OUT TROLLEY 200L.	26
" T-M " TROLLEY 200L.	26
SKALATOR TROLLEY 120L. - 140L.	27
" E-M " TROLLEY 140L.	28
HANDICAPPED TROLLEY 62L.	28
MULTI-BASKET TROLLEY	29
SHOPPING BASKET 25L. - 50 L.	29



ACCESSORIES

SHOPPING TROLLEY -STANDARD LINE-	30
SHOPPING TROLLEY -ANTI-THEFT LINE-	31
SHOPPING TROLLEY -SPECIAL LINE-	32
TROLLEY SHELTERS // TROLLEY BAY	33-34
PRODUCT CERTIFICATE	35
ADDRESSES	36

AENOR



Producto
Certificado

A12 / 00001

UNE-EN 1929-1
UNE-EN 1929-2
UNE-EN 1929-3
UNE-EN 1929-4
UNE-EN 1929-7



S P É C I F I C A T I O N S T E C H N I Q U E S

CARACTÉRISTIQUES

Nos chariots sont composés d'un panier pour le transport de marchandises, d'une plateforme équipée de roulettes, d'une poignée et d'un battant simple avec ou sans porte bébé.

Les capacités des paniers varient de: 25L à 240L en version standard et de 90L à 242L en version hybride Polysteel.

FINITIONS

Fabriqué à partir de matériaux de première qualité en conformité avec les normes UNE EN 10016 / UNE EN 10305. Les diamètres des fils acier utilisés vont de 3 mm. à 14 mm, les soudures sont réalisées robotiquement avec une pénétration moyenne de 15% (suivant les diamètres des fils utilisés).

FABRICATION CONFORME AUX NORMES UNE EN 1929-1 / 1929-2 / UNE EN 1929-3 / UNE ENB 1929-4 / 1929-7.

PROTECTION REVÊTEMENT

Zingage: Réalisé par bain électrolytique avec une épaisseur de 50 à 60 microns.

Finition: Réalisée par un vernis polyester transparent de 60 ± 80 microns polymérisés à 200 °C.

PROPRIÉTÉS CHIMIQUES

Brouillard Salin: (ASTM B 117) > 700 Heures.

Chambre humide: (DIN 50017) > 1000 Heures.

Inmersion eau distillée: (40 °C) > 700 Heures.

PROPRIÉTÉS MÉCANIQUES

Brillance 60 (DIN 53151) 100%

Adhérence (Quadrillage 2 mm.) 100%

Dureté (Crayon INTA 160302 - 2) > 3 h.

Résistance à l'impact (ASTM D 2974) Bille 12 mm

Direct 70 cm.

Inverse 70 cm.

Dureté PERS > 300

Flexibilité Mandrin Conique (DIN 53156) 5 mm.

Les tests chimiques comme mécaniques ont été réalisés sur des échantillons d'acier phosphaté micro cristalline (Bonder 132) avec une épaisseur de application de 50±60 microns et polymérisés à 200 °C.

CONFORT, ERGONOMIE, SÉCURITÉ

Fabriqué en conformité avec tous les principes de confort, d'ergonomie et de sécurité répondant aux normes UNE-EN 1929-1 / UNE-EN 1929-2 / UNE-EN 1929-3 / UNE-EN 1929-4 / UNE-EN 1929-7.

POIGNÉE ERGOBOX ET POIGNÉE OVALE ERGOGRIP

Fabriquée en Polypropylène injecté avec protection anti-UV intégrée.

Matériels résistants aux acides, détergents, aux solutions salines, libres d'incompatibilité électromagnétique.

POIGNÉE RONDE

Poignée fabriquée en tube acier galvanisé de première qualité, emboutie aux extrémités afin d'éviter la rotation, recouverte d'un papier plastifié recevant votre sérigraphie et d'une enveloppe polycarbonate pour une meilleure protection Anti-U.V.

Embouts de poignée fabriqués en P. V. C. de grande résistance, avec nervures latérales et équipés de bagues et de vis, assurant un emboîtement parfait de la poignée sur le chariot.



T E C H N I C A L S P E C I F I C A T I O N S

CHARACTERISTICS

A range of trolleys with a rigid wire basket for the transport of goods, attached to a wheeled chassis with a handle and the option of a simple rear tray or baby seat. Capacity ranges from 50 to 240 litres. In standard line.

FINISHING

Made with high quality materials in accordance with European Standards UNE EN 10016 / UNE EN 10303. Steel wire thickness from 3 to 14 mm diameter. All joints have welding penetrations averaging 15% (depending on the diameter). Technical aspects such as stability, loading, notch impact, working life and nominal volume are in accordance with standard UNE EN 1929-1 / prEN 1929-2/ prEN 1929-3 / prEN 1929-4 / prEN1929-7.

COATING

Zinc coated: electrolytic zinc treatment applied in a layer from 10 to 20 microns thick.
Covering: electrostatically coated with 60 to 80 microns of clear polyester polymerised at 200 °C.
Injected polypropylene.

CHEMICAL RESISTANCE

Salt Spray: (ASTM B 117) > 700 HOURS.
Moisture test chamber: (DIN 50017) > 1000 hours.
Distilled water immersion: (40 °C) > 700 hours.

MECHANICAL PROPERTIES

BRIGHTNESS 60 (DIN 50017) 100 %
ADHERENCE (2 mm. GRID SQUARE) 100 %
HARDNESS (PENCIL-PROOF INTA 160302-2) > 3 HOURS
NOTCH STRENGTH (ASTM D 2974) BALL 12 mm.
DIRECT 70 CM.
INVERSE 70 CM.
PERSOZ HARDNESS > 300
CONE MANDREL FLEXIBILITY (DIN 53156) 5 mm.

Steel tubes protected with 50 to 60 microns of microcrystalline phosphated coating (BONDER 132) and polymerised at 200 °C were used to carry out the chemical and mechanical tests.

ERGONOMICS, COMFORT AND SECURITY

All trolleys in accordance with all confort and ergonomic requirements within Standards UNE-EN 1929-1 / UNE-EN 1929-2 / UNE-EN 1929-3 / UNE-EN 1929-4 / UNE-EN1929-7.

ERGOBOX AND ERGOGRIP HANDLES

Injected polypropylene protected against UV radiation.
Resistance against acids, detergents and salt solutions, free of electromagnetic incompatibility.

STANDARD ROUND HANDLE

Galvanised high quality steel tube including lateral inserts to stop the handle rotating.
Personalised screen-print available on the handle with a polycarbonate sleeve covering the handle for protection of UV radiation. High strength side mouldings, made of PVC with lateral ribbing to engage the handle and fitted with screws create a joint between the handle and the trolley.

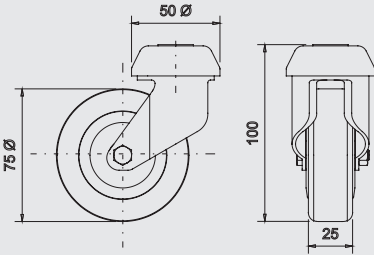

ROULETTE PIVOTANTE 75 Ø

Roulette pivotante, Chape en acier embouti, Finition zinguée, Pivot sur double chemin de billes, Axe de roue boulonné, Trou central.
Corps de roue polypropylène, Bandage caoutchouc thermoplastique gris non tachant, avec pare-fils, roulements à billes de précision, avec pare-fils

Diamètre de roue - 75 mm.
Largeur de bandage - 25 mm.
Diamètre des trous - 10.3 mm.
Déport - 30 mm.
Diamètre d'encombrement - 135 mm
Hauteur - 100 mm.
Capacité de charge dynamique - 75 kg./ daN
Capacité de charge statique - 150 kg / daN
Température - 20 / + 60°C
Norme - EN 12530
Poid - 0.301 kg. / daN

75 Ø SWIVEL WHEEL

Swivel Castor, housing made of zinc-chromatised pressed steel, double ball bearing swivel head, wheel axle with nut, wheel made of Polypropylene, grey non-marking, tread made of thermoplastic rubber, threadguards and plain bearing, single bolt hole.

Wheel diameter - 75 mm.
Width of tread - 25 mm.
Center hole - 10.3 mm.
Offset - 30 mm.
Swept radius Ø - 135 mm
Overall height - 100 mm.
Dynamic load capacity - 75 kg./ daN
Static load capacity - 150 kg / daN
Temperature - 20 / + 60°C
Norm - EN 12530
Weight - 0.301 kg. / daN

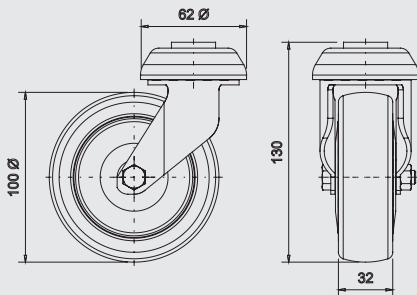

ROULETTE PIVOTTANTE 100 Ø

Roulette pivotante, Chape en acier embouti, Finition zinguée, Pivot sur double chemin de billes, Axe de roue boulonné, Trou central.
Corps de roue polypropylène, Bandage caoutchouc thermoplastique, gris non tachant, avec pare-fils plastiques, roulements rouleaux.

Diamètre de roue - 100 mm.
Largeur de bandage - 32 mm.
Diamètre des trous - 11 mm.
Déport - 35 mm.
Diamètre d'encombrement - 170 mm
Hauteur - 129 mm.
Capacité de charge dynamique - 80 kg./ daN
Capacité charge statique - 160 kg / daN
Température - 20 / + 60°C
Norme - EN 12530
Poid - 0.534 kg. / daN

100 Ø SWIVEL WHEEL

Swivel Castor, housing made of zinc-chromatised pressed steel, double ball bearing swivel head, wheel axle with nut, wheel made of Polypropylene, grey non-marking, tread made of thermoplastic rubber, threadguards and roller bearing, single bolt hole.

Wheel diameter - 100 mm.
Width of tread - 32 mm.
Center hole - 11 mm.
Offset - 35 mm.
Swept radius Ø - 170 mm
Overall height - 129 mm.
Dynamic load capacity - 80 kg./ daN
Static load capacity - 160 kg / daN
Temperature - 20 / + 60°C
Norm - EN 12530
Weight - 0.534 kg. / daN

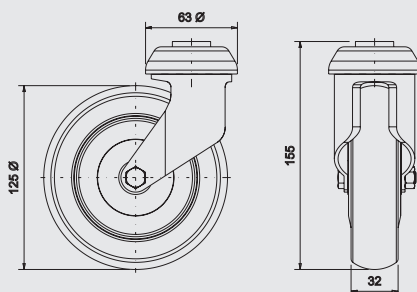

ROULETTE PIVOTANTE 125 Ø

Roulette pivotante, Chape en acier embouti, Finition zinguée, Pivot sur double chemin de billes, Axe de roue boulonné, Trou central.
Corps de roue polypropylène, bandage caoutchouc semi-élastique gris non tachant, roulement à billes de précision avec pare-fils

Diamètre des trous - 125 mm.
Largeur de bandage - 32 mm.
Diamètre des trous - 13 mm.
Déport - 38 mm.
Diamètre d'encombrement - 201 mm
Hauteur - 155 mm.
Capacité charge dynamique- 100 kg./ daN
Capacité charge statique - 200 kg / daN
Température - 20 / + 60°C
Norme - EN 12530
Poid - 0.661 kg. / daN

125 Ø SWIVEL WHEEL

Swivel Castor, housing made of zinc-chromatised pressed steel, double ball bearing swivel head, wheel axle with nut, wheel made of Polypropylene, grey non-marking, tread made of thermoplastic rubber, threadguards and precision ball bearing, single bolt hole.

Wheel diameter - 125 mm.
Width of tread - 32 mm.
Center hole - 13 mm.
Offset - 38 mm.
Swept radius Ø - 201 mm
Overall height - 155 mm.
Dynamic load capacity - 100 kg./ daN
Static load capacity - 200 kg / daN
Temperature - 20 / + 60°C
Norm - EN 12530
Weight - 0.661 kg. / daN

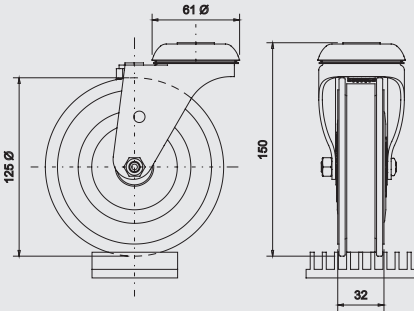

ROULETTE PIVOTANTE 125 Ø
RAMPE FREIN CENTRAL

Roulette pivotante, fourche en tôle acier, finition zinguée chromatisée, roulement pivotant avec deux rangées de billes graissées, anneau protecteur en plastique, essieu de la roulette vissé, double profil de polyuréthane sur essieu avec roulement à bille étanche. Les profils portent un anneau intérieur en caoutchouc dur qui presse un patin de freinage quand les profils rentrent dans les rainures des rampes.
Instructions: L'usage sur des sols non appropriés en extérieur peuvent endommager et affecter la durée de vie des roulettes.

- Diamètre de roue - 125 mm.
- Largeur de bandage - 32 mm.
- Diamètre des trous - 12,4 mm.
- Déport - 40 mm.
- Diamètre d'encombrement - 205 mm
- Hauteur - 150 mm.
- Capacité de charge dynamique - 120 kg./ daN
- Capacité de charge statique - 180 kg / daN
- Temperature - 20 / + 60°C
- Norme - DIN EN 12530
- Poid - 0.748 kg. / daN

125 Ø SWIVEL AUTOWALK
WHEEL WITH CENTRAL BRAKE

Walkway castor manufactured from steel with lubricated twin-row ball bearing swivel head. A sealing ring provides additional protection against dust and dirt. Double polyurethane tread with sealed ball bearing ring. The brake is activated when the outer treads enter the travelator combs causing the inner rubber ring to engage a rubber catch which acts as a brake. Warning: Irregular and outdoor grounds might affect working life and will cause malfunction to the wheels.

- Wheel diameter - 125 mm.
- Width of tread - 32 mm.
- Center hole - 12.4 mm.
- Offset - 40 mm.
- Swept radius Ø - 205 mm
- Overall height - 150 mm.
- Dynamic load capacity - 120 kg./ daN
- Static load capacity - 180 kg / daN
- Temperature - 20 / + 60°C
- Norm - DIN EN 12530
- Weight - 0.748 kg. / daN

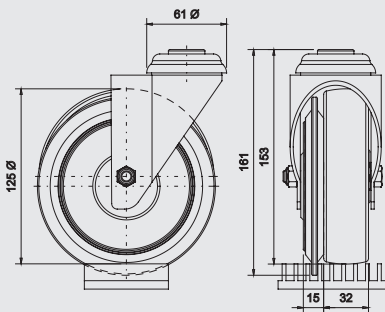

ROULETTE PIVOTANTE 125 Ø
RAMPE FREIN DE DISQUE

Roulette pivotante pour chariots libre service avec frein de roue pour tapis roulants, roue flasque avec un double roulement à billes et frein intégré droit ou gauche, Chape en acier embouti, Finition zinguée, Pivot sur double chemin de billes, Axe de roue boulonné. Caractéristiques: longueur du profil: env. 2,75 mm, largeur de la rainure env. 5,7 mm, profondeur de la rainure: > 10,0 mm. Utiliser en surface plane.
Instructions: L'usage sur des sols non appropriés en extérieur peuvent endommager et affecter la durée de vie des roulettes.

- Diamètre de roue - 125 mm.
- Largeur de bandage - 32 mm.
- Diamètre des trous - 12,3 mm.
- Déport - 40 mm.
- Diamètre d'encombrement - 211 mm
- Hauteur - 153 mm.
- Capacité de charge dynamique - 100 kg./ daN
- Capacité de charge statique - 250 kg / daN
- Temperature - 20 / + 60°C
- Norme - DIN EN 12530
- Poid - 0.853 kg. / daN

125 Ø SWIVEL AUTOWALK
WHEEL WITH DISC BRAKE

Walkway Castor with automatic side brake for moving walkways, housing made of pressed steel, zinc chromatised, double ball bearing swivel head, flanged wheel with one ball race, left and right hand design, wheel centre made of plastic, tread made of rubber, with threadguards and precision ball bearing, flanged wheel made of plastic, track wheel-Ø 127 mm., track width 4 mm., engagement travel 8 mm., single bolt hole. Designed for the following autowalk systems: Track width: approx. 2,75 mm., groove width: approx. 5,7 mm., groove depth: > 10 mm. Warning: Irregular and outdoor grounds might affect working life and will cause malfunction to the wheels.

- Wheel diameter - 125 mm.
- Width of tread - 32 mm.
- Center hole - 12.3 mm.
- Offset - 43 mm.
- Swept radius Ø - 211 mm
- Overall height - 153 mm.
- Dynamic load capacity - 100 kg./ daN
- Static load capacity - 250 kg / daN
- Temperature - 20 / + 60°C
- Norm - DIN EN 12530
- Weight - 0.853 kg. / daN

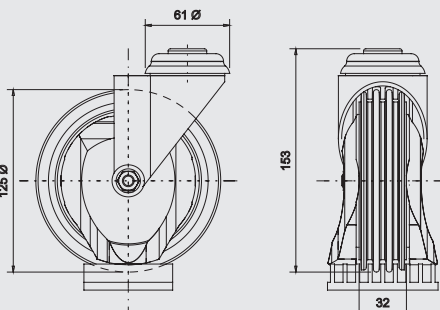

ROULETTE PIVOTANTE 125 Ø
RAMPE DOUBLE FREIN LATÉRAL

Roulettes pivotantes pour chariots libre service avec frein intégré pour tapis roulants, Chape en acier embouti, Finition zinguée, Pivot sur double chemin de billes, Axe de roue boulonné, Corps de roue polypropylène, Bandage: polyuréthane, 4 joues, peigne auto-nettoyant avec pare-fils, roulements à billes de précision, distance entre les joues: env. 4,5 mm, épaisseur des joues: env. 4,0 mm. Caractéristiques: longueur du profil: env. 2,75 mm, largeur de la rainure env. 5,7 mm, profondeur de la rainure: > 10,0 mm. Utiliser en surface plane.
Instructions: L'usage sur des sols non appropriés en extérieur peuvent endommager et affecter la durée de vie des roulettes.

- Diamètre de roue - 125 mm.
- Largeur de bandage - 32 mm.
- Diamètre des trous - 12,3 mm.
- Déport - 40 mm.
- Diamètre d'encombrement - 205 mm
- Hauteur - 153 mm.
- Capacité de charge dynamique - 80 kg./ daN
- Capacité de charge statique - 200 kg / daN
- Temperature - 40 / + 60°C
- Norme - DIN EN 12530
- Poid - 0.645 kg. / daN

125 Ø SWIVEL AUTOWALK
WHEEL WITH DOUBLE SIDE BRAKE

Walkway Castor, threadguards with integrated brake shoe for moving walkways, housing made of pressed steel, zinc-chromatised, double ball bearing swivel head, threadguards with integrated brake shoe, designed for left and right hand use, wheel centre and tread made of polyurethane, with threadguards and precision ball bearing, 4 tracks, selfcleaning between tracks, distance between tracks approx. 4,5 mm., track width approx. 4 mm., single bolt hole. Designed for the following autowalk systems: Track width: approx. 2,75 mm., groove width: approx. 5,7 mm., groove depth: > 10 mm. Warning: Irregular and outdoor grounds might affect working life and will cause malfunction to the wheels.

- Wheel diameter - 125 mm.
- Width of tread - 32 mm.
- Center hole - 12.3 mm.
- Offset - 40 mm.
- Swept radius Ø - 205 mm
- Overall height - 153 mm.
- Dynamic load capacity - 80 kg./ daN
- Static load capacity - 200 kg / daN
- Temperature - 40 / + 60°C
- Norm - DIN EN 12530
- Weight - 0.645 kg. / daN



C H A R I O T S L I B R E S E R V I C E

Marsanz

NOS CHARIOTS SONT DEVELOPPÉS POUR RÉPONDRE À TOUTES LES
DEMANDES DU MARCHÉ.

OUR TROLLEYS ARE DESIGNED TO FULFIL THE LATEST MARKET DEMANDS

LEUR RÉSISTANCE, ENDURANCE ET DURABILITÉ ONT RÉUSSI À
FAIRE DE MARSANZ UNE MARQUE DE RÉFÉRENCE.

ITS RESISTANCE, STRENGTH AND DURABILITY HAS MADE MARSANZ
A LEADING BRAND REFERENCE



AVEC UNE GRANDE VARIÉTÉ D'ACCESSOIRES, NOUS
ARRIVONS À REpondre À TOUS LES BESOINS DE NOS
CLIENTS

WE COVER ALL OUR CUSTOMER NEEDS BY OFFERING A
WIDE RANGE OF ACCESSORIES



S H O P P I N G T R O L L E Y

Marsanz



CONFORT ET SÉCURITÉ
PARFAITE FINITION

SAFETY AND COMFORT: THE REASSURANCE
OF A PERFECT FINISHING



LA MODERNITÉ DU CHARIOT, LE
DESIGN INNOVANT, LA LARGE
PALETTE DE COULEURS, LA
FACILITÉ D'UTILISATION VOUS
PERMETTENT DE DYNAMISER VOS
ACHATS

EASY TO MOVE, WIDE RANGE OF
COLOURS. THE NEW DESIGNS
PROVIDES THE TROLLEY WITH A
MODERN APPEARANCE



UN LARGE ÉVENTAIL DE COULEURS
EN HARMONIE AVEC VOS ENSEIGNES.

WIDE RANGE OF COLOURS UPON
REQUEST



CLOISON DE SÉPARATION

VERTICAL BASKET DIVIDER



La solution parfaite pour les produits fragiles.

The best solution to separate fragile/delicate products while shopping.

PETITE CLOISON DE SÉPARATION

BASKET DIVIDER



La solution pour ranger et protéger des produits fragiles.

The best solution to separate the small fragile/delicate products.

PROFILS DE CORNIÈRE DE PROTECTION PVC
PLASTIC PROTECTORS FOR CORNERS AND TOP BASKET PROFILE



Le profil de protection de la partie supérieure du panier ou des angles vous permettent de réaliser la protection du panier ainsi que de prolonger la durée de vie de votre parc.

These extra protections have been developed to improve the appearance of the trolley protecting the basket and warranting a longer working life for your trolley fleet.

Une solution pour gagner du volume sous le panier (valable uniquement en version modèle Standard). L'inclinaison de la grille vous permet d'utiliser ce chariot sur les tapis mécaniques.

Extra loading capacity for the standard line trolleys. Perfect trolley nesting accuracy. Allow to use in travelator systems

GRILLE INFÉRIEURE

GRILL BASE



FINITION CHARIOTS PEINTS

PAINTED COLOUR TROLLEYS

Une variété de couleurs est disponible pour les chariots métal.
Une finition parfaite garantie grâce au zinguage par électrolyse, au revêtement de peinture polyester et au vernis de finition polymérisé à 200 °C.

Wide range of colours for wire trolleys.
Zinc metallic coating, coloured polyester covering and synthetic polish that warranty an excellent protection



PORTE-BÉBÉ DOUBLE FONCTION

DOUBLE FONCTION BABY SEAT



Le volet rabattable du siège vous permet de disposer d'un espace supplémentaire idéal pour les produits fragiles.

Get an extra loading place (specially to carry fragile products) by folding up the plastic baby seat.

DOUBLE PORTE-BÉBÉ
TWIN BABY SEAT



Siège élaboré pour accueillir deux enfants

The call to attract customers with two children

PICTOGRAMMES D'AVERTISSEMENT
BABY SEAT WITH WARNING INSTRUCTIONS



Support avec pictogrammes reprenant l'utilisation correcte du chariot.

To display the proper use of the trolley.

COLORIS POUR EMBOUTS DE POIGNÉE ET PORTE-BÉBÉ

STANDARD COLOURS FOR PLASTIC END CAPS AND BABY SEATS

RAL 1023



RAL 6028



RAL 2004



RAL 5005



RAL 7001



RAL 6018



RAL 3011



RAL 1028



NEGRO BLACK



RAL 3020



COQUE BÉBÉ
 BABY CRADLE



Sa conception ainsi que les matériaux employés font du coque bébé le siège idéal pour les petits enfants, et ceci sans réduction du volume du panier.

Customers will appreciate the extra provided service. Designed in padded material to achieve maximum comfort.

The full basket capacity remain.

SUPPORT PUBLICITAIRE
 ADVERTISEMENT HOLDER



Outil promotionnel vous permettant d'optimiser la rentabilité de votre chariot grâce à la publicité, ainsi que de mettre en avant auprès de votre clientèle vos campagnes promotionnelles.

The easiest way to increase the trolley profitability, attracting your customer's attention to your store promotions.

CORBEILLE SUPPORT COQUE BÉBÉ

WIRE CRADLE FOR NEWBORN CAR SEAT



Complément parfait pour toute sorte de coque bébé

Perfect accessories suitable for any newborn car seat.

CROCHET PORTE SAC PVC EXTÉRIEUR

PLASTIC BAG HOOK

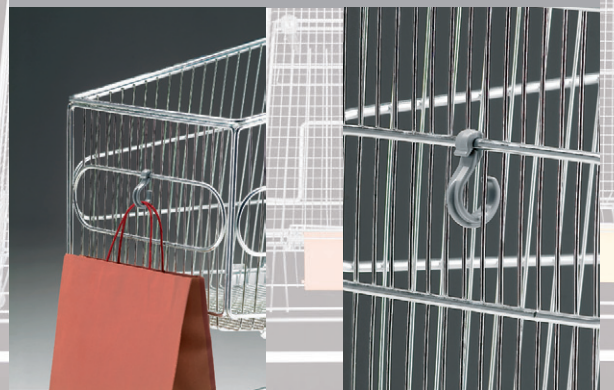

Accessoire croché au panier permettant de suspendre des sacs pleins ou vides.

Made of resistant plastic it is the best way to carry personal belongings or bag-packaged products. Easy to fit.

SUPPORT PACKS FIXE

FIXED BOTTLE RACK



Support packs fixe relié au panier.



Fixed bottle rack.

SUPPORT PACKS PLIABLE

FOLDING BOTTLE RACK



Facilement pliable, l'accessoire idéal pour le transport des packs, vous permettant un gain de place dans le panier du chariot.

It has been developed to carry bottle crates or big volume packages without reducing the basket loading capacity.

The folding bottle rack will fold up when the trolley is nested.

La conception de notre poignée ERGOBOX, résultat d'une étude ergonomique approfondie, vous offre une résistance, une maniabilité, un confort d'utilisation incomparables, ainsi qu'un grand espace publicitaire ou promotionnel tout en intégrant un système de consignation.

Our proven resistant ERGOBOX handle is the outcome of a meticulous study of ergonomy, providing comfortable use of the trolley with its handle design by having a large advertisement area. It comes with an integrated coin deposit system.



POIGNÉE "ERGOBOX" HANDLE "ERGOBOX"
MEBM



SUPPORT SCANNER INDIVIDUEL
SCANNER HOLDER FOR "ERGOBOX"
SSE



LOUPE RABATTALE "ERGOBOX"
MAGNIFYING GLASS
LPMEBX



ORIGINAL POUR CUSTOMISER
ORIGINAL FOR CUSTOMIZED HANDLE
ORL

LOGO PERSONNALISÉ
CUSTOMIZED HANDLE
LMC

ORIGINAL POUR CUSTOMISER "ERGOGRIP"
ORIGINAL CUSTOMIZED HANDLE FOR "ERGOGRIP"
ORL-E

LOGO POUR POIGNÉE "ERGOGRIP"
CUSTOMIZED HANDLE FOR "ERGOGRIP"
LMC-E



POIGNÉE ERGOGRIP (OVALE) ET POIGNÉE RONDE (STANDARD)
ERGOGRIP HANDLE (OVAL) AND ROUND HANDLE (STANDARD)



SUPPORT SCANNER
SINGLE SCANNER HOLDER
SSIND



PROMOBX POIGNÉE RONDE
PROMOBX FOR ROUND HANDLE
PMMR

PROMOBX POIGNÉE OVALE
PROMOBX FOR OVAL HANDLE
PMMO

Une solution simple pour disposer de plus d'espace publicitaire, pour poignée Promobox, Ergogrip (ovale) ou ronde.

The best promotion and advertisement solution. Available in round and oval handle.



VARILOC
MCVH

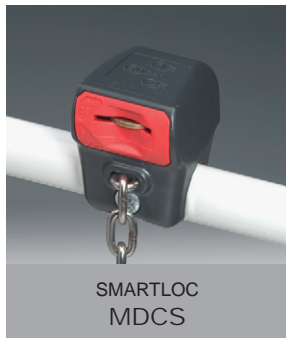

SMARTLOC
MDCS



EUROLOC POIGNÉE RONDE
EUROLOC FOR ROUND HANDLE
MCSEURR

EUROLOC POIGNÉE OVALE
EUROLOC FOR OVAL HANDLE
MCSEURO



CLÉ DE DÉPART 1 mts.
STARTING CHAIN 1 mts..
CI-S1

Finition métallique pour des conditions extrêmes. Très résistant, solide et inoxydable. Matériel: zinc coulé à pression et revêtu de poudre.

The housing and clamping elements are made of metal. This is the lock for resisting extreme loads. Particularly strong, and non-rusting. Material: Powder-coated zinc die casting.

Fabriqué en plastique très robuste et de grande qualité. De montage facile.

Manufactured with proven resistance top quality plastic. Customer friendly use. Easy fitting to the handle with just a single bolt.

Fabriqué en plastique d'une grande résistance. Grâce à son positionnement latéral vous disposerez d'un espace publicitaire plus important sur la poignée. Disponible pour poignées ovales et rondes.

Manufactured with proven resistance top quality plastic, the euroloc is integrate in the end cap. Available for standard round and oval handles.



CHARIOT ENFANT
CHILDREN TROLLEY

25 L.



50 L.

MINI-CHARIOT
MINI-TROLLEY



60 L.

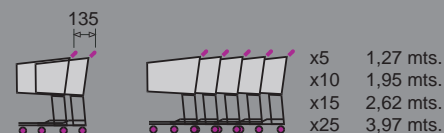
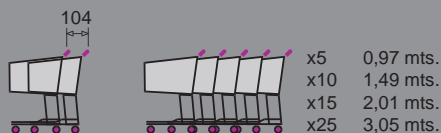
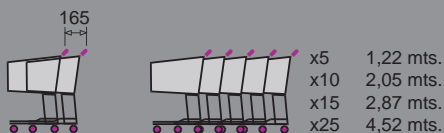
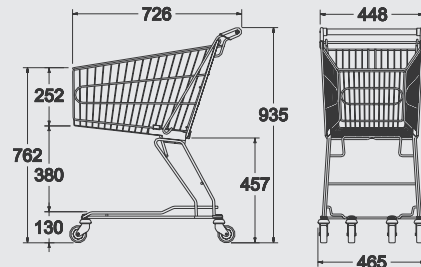
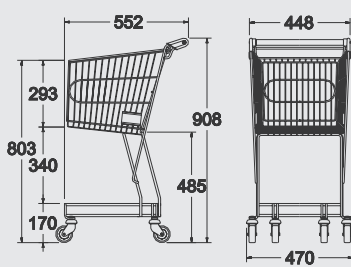
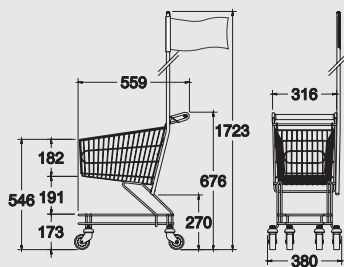

ROUES
WHEELS



25

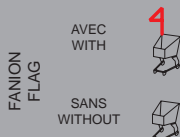

CASCB02501	6,45 kg.
CASSB02501	5,55 kg.

50

CASSP05001	8,50 kg.
------------	----------

60

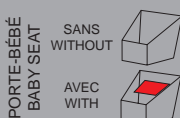

CASSP06001	11,4 kg.
CASCP06001	12,9 kg.

80 L.



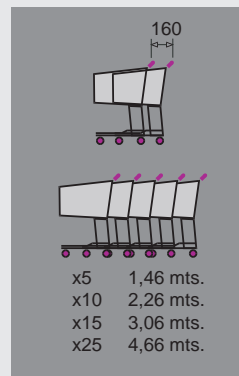
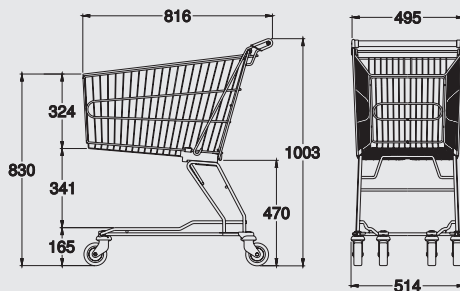
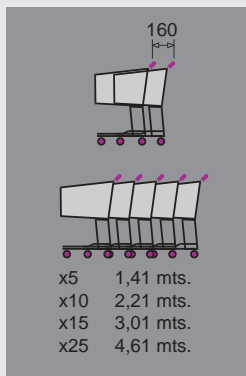
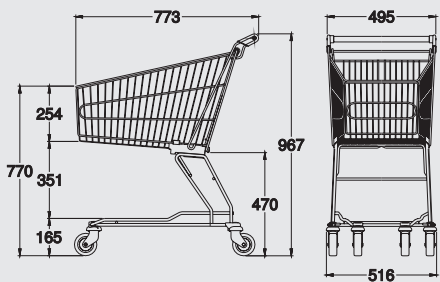

100 L.



ROUES
WHEELS





80

PORTE-BÉBÉ
 BABY SEAT
 SANS
 WITHOUT 
 AVEC
 WITH 

CASSP08001 13,35 kg.	CASSP08002 14,35 kg.
CASCP08001 14,85 kg.	CASCP08002 15,85 kg.

100

PORTE-BÉBÉ
 BABY SEAT
 SANS
 WITHOUT 
 AVEC
 WITH 

	CASSP10002 15,35 kg.
	CASCP10002 16,85 kg.

120L.



140 L.

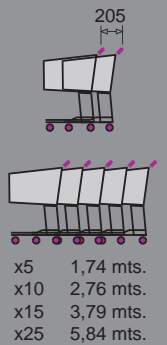
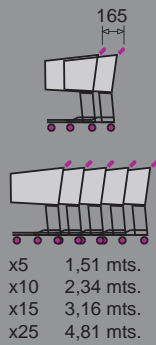
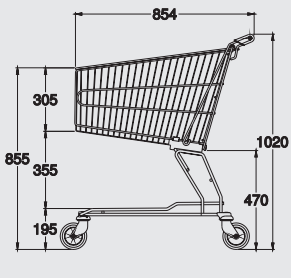

ROUES WHEELS



120

PORTE-BÉBÉ
 BABY SEAT
 SANS
 WITHOUT
 AVEC
 WITH

SANS WITHOUT	CASSP12003	17,75 kg.		
AVEC WITH	CASCP12003	19,25 kg.		

140

PORTE-BÉBÉ
 BABY SEAT
 SANS
 WITHOUT
 AVEC
 WITH

SANS WITHOUT	CASSP14003	21,6 kg.	CASSP14006	21,8 kg.	CASSP14007	22,2 kg.	CASSP14008	21,6 kg.
AVEC WITH	CASCP14003	23,10 kg.	CASCP14006	23,3 kg.	CASCP14007	23,7 kg.	CASCP14008	23,10 kg.

150 L.

PLATEFORME GRANDE CHARGE
STANDARD TROLLEY FOR CRATES



160 L.

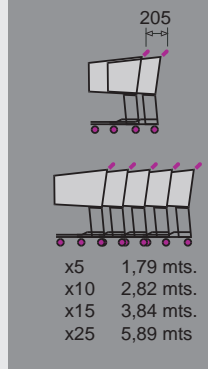
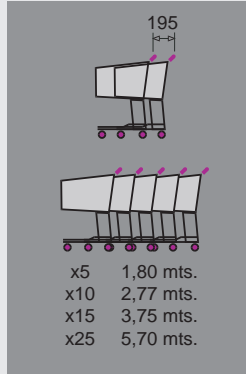
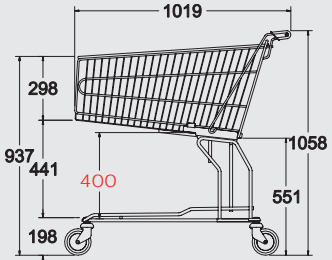

ROUES WHEELS



PORTE-BÉBÉ
BABY SEAT

SANS
WITHOUT

AVEC
WITH

CASGCS1503
25,65 kg.

CASGCS1506
25,85 kg.

CASGCS1507
26,25 kg.

CASGCS1508
25,65 kg.

CASGCP1503
27,15 kg.

CASGCP1506
27,35 kg.

CASGCP1507
27,75 kg.

CASGCP1508
27,15 kg.

PORTE-BÉBÉ
BABY SEAT

SANS
WITHOUT

AVEC
WITH

CASSP16003
22,75 kg.

CASSP16006
22,95 kg.

CASSP16007
23,35 kg.

CASSP16008
22,75 kg.

CASCP16003
24,25 kg.

CASCP16006
24,45 kg.

CASCP16007
24,85 kg.

CASCP16008
24,25 kg.

150

160

180 L.



210 L.

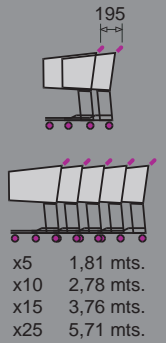
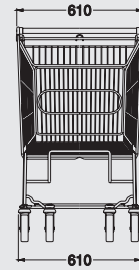
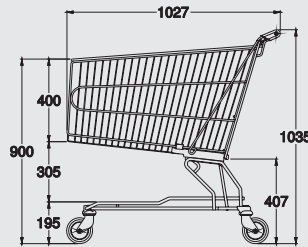
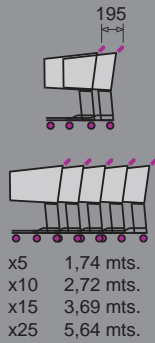
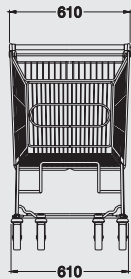
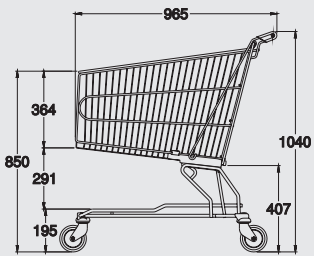

ROUES WHEELS



180

PORTE-BÉBÉ
 BABY SEAT
 SANS
 WITHOUT
 AVEC
 WITH

CASSP18003 24 kg.	CASSP18006 24,2 kg.	CASSP18007 24,6 kg.	CASSP18008 24 kg.
CASCP18003 25,5 kg.	CASCP18006 25,7 kg.	CASCP18007 26,1 kg.	CASCP18008 25,5 kg.

210

PORTE-BÉBÉ
 BABY SEAT
 SANS
 WITHOUT
 AVEC
 WITH

CASSP21003 25,3 kg.	CASSP21006 25,3 kg.	CASSP21007 25,8 kg.	CASSP21008 25,3 kg.
CASCP21003 26,8 kg.	CASCP21006 26,8 kg.	CASCP21007 27,3 kg.	CASCP21008 26,8 kg.

212 L.



240 L.

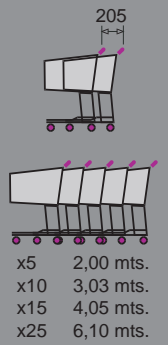
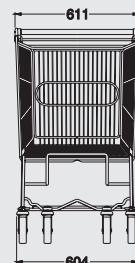
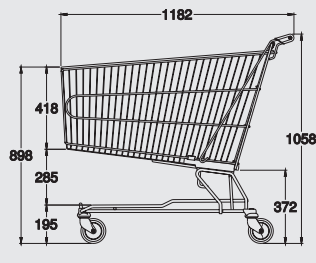
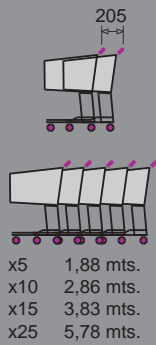
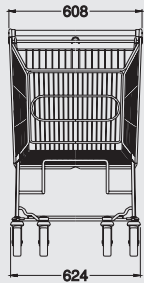
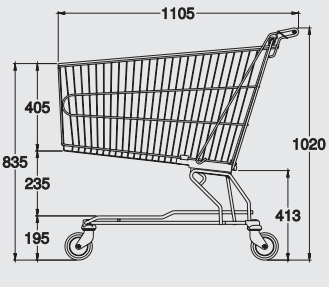

ROUES WHEELS



PORTE-BÉBÉ
 BABY SEAT
 SANS
 WITHOUT
 AVEC
 WITH

CASSP21203
24,6 kg.

CASSP21206
24,8 kg.

CASSP21207
25,2 kg.

CASSP21208
24,6 kg.

CASCP21203
26.1 kg.

CASCP21206
26,3 kg.

CASCP21207
26,7 kg.

CASCP21208
26.1 kg.

PORTE-BÉBÉ
 BABY SEAT
 SANS
 WITHOUT
 AVEC
 WITH

CASSP24003
27,3 kg.

CASSP24006
27,5 kg.

CASSP24007
27,9 kg.

CASSP24008
27,3 kg.

CASCP24003
28,8 kg.

CASCP24006
29 kg.

CASCP24007
29,4 kg.

CASCP24008
28,8 kg.

212

240

80 L.



100 L.

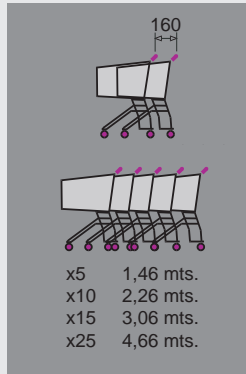
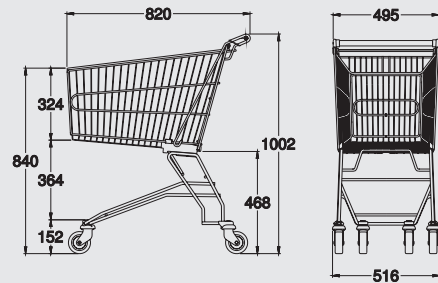
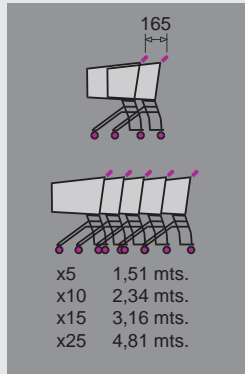
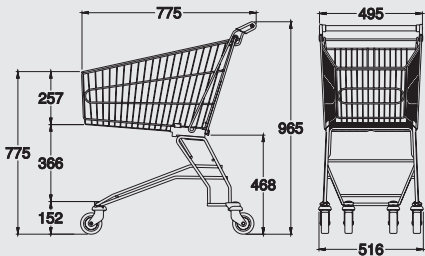

ROUES
WHEELS



80

PORTE-BÉBÉ
BABY SEAT

SANS
WITHOUT

AVEC
WITH

CAASP08001 13,60 kg.	CAASP08002 14,50 kg.
CAACP08001 16,90 kg.	CAACP08002 16 kg.

100

PORTE-BÉBÉ
BABY SEAT

SANS
WITHOUT

AVEC
WITH

	CAASP10002 15,55 kg.
	CAACP10002 17,05 kg.

120 L.



140 L.

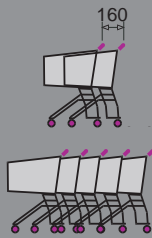
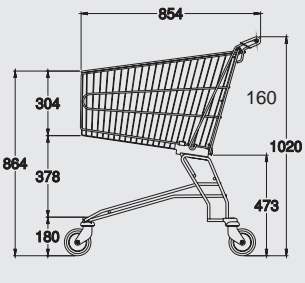

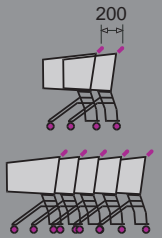

- x5 1,42 mts.
- x10 2,22 mts.
- x15 3,02 mts.
- x25 4,62 mts.



- x5 1,72 mts.
- x10 2,72 mts.
- x15 3,72 mts.
- x25 5,72 mts.

ROUES
WHEELS



PORTE-BÉBÉ
 BABY SEAT
 SANS
 WITHOUT 
 AVEC
 WITH 

CAASP12003
17,95 kg.

CAASP12006
18,15 kg.

CAASP12007
18,55 kg.



CAASP12008
17,95 kg.

CAACP12003
19,45 kg

CAACP12006
19,65 kg.

CAACP12007
20,05 kg.

CAACP12008
19,45 kg.

PORTE-BÉBÉ
 BABY SEAT
 SANS
 WITHOUT 
 AVEC
 WITH 

CAASP14003
22,10 kg.

CAASP14006
22,3 kg.

CAASP14007
22,7 kg.

CAASP14008
22,10 kg.

CAACP14003
23,60 kg.

CAACP14006
23,8 kg.

CAACP14007
24,2 kg.

CAACP14008
23,60 kg.

120
140

150 L.

CHARIOT AVEC PANIER SURÉLEVÉ
ANTI-THEFT TROLLEY COMFORT BASKET



160 L.

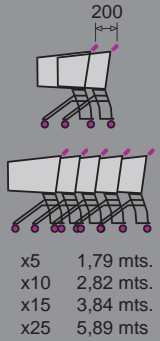
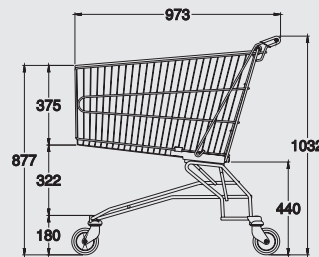
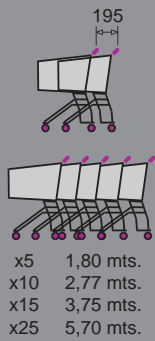
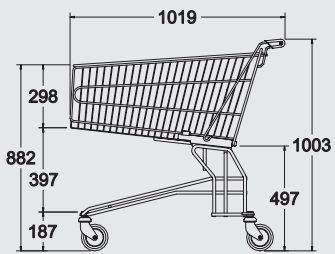

ROUES
WHEELS



150

PORTE-BÉBÉ
BABY SEAT

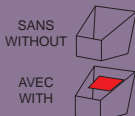

CAACES1503 25,50 kg.	CAACES1506 25,70 kg.	CAACES1507 26,10 kg.	CAACES1508 25,50 kg.
CASGCP1503 27,15 kg.	CAACEP1506 27,20 kg.	CAACEP1507 27,6 kg.	CAACEP1508 27,00 kg

160

PORTE-BÉBÉ
BABY SEAT

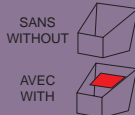

CAASP16003 23,10 kg.	CAASP16006 22,5 kg.	CAASP16007 23,7 kg.	CAASP16008 23,10 kg.
CAACP16003 24.60 kg.	CAACP16006 24,8 kg.	CAACP16007 25,2 kg.	CAACP16008 24.60 kg.

180 L.



210 L.

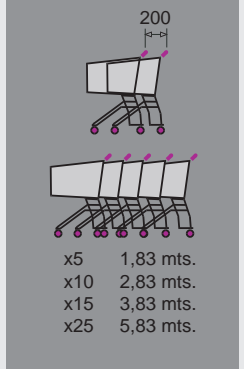
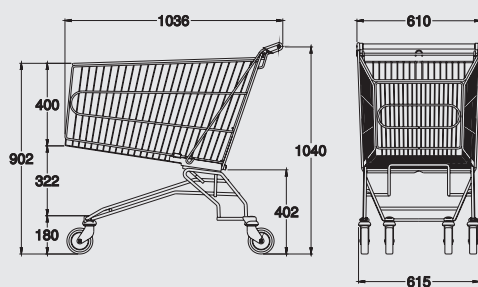
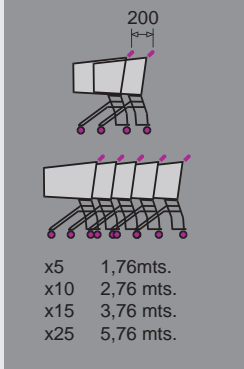
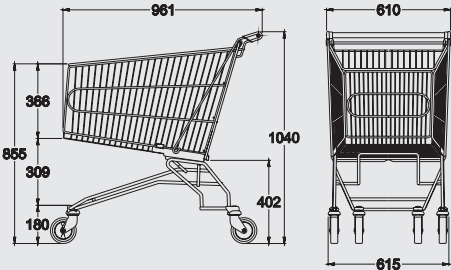

ROUES
WHEELS



PORTE-BÉBÉ
BABY SEAT

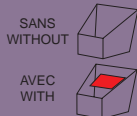

CAASP18003
23,6 kg.

CAASP18006
23,8 kg.

CAASP18007
24,2 kg.

CAASP18008
23,6 kg.

CAACP18003
25.10 kg.

CAACP18006
25,3 kg.

CAACP18007
25,7 kg.

CAACP18008
25.10 kg.

PORTE-BÉBÉ
BABY SEAT

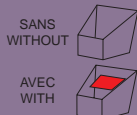

CAASP21003
24,70 kg.

CAASP21006
24,9 kg.

CAASP21007
25,3 kg.

CAASP21008
24,70 kg.

CAACP21003
26.20 kg.

CAACP21006
26,4 kg.

CAACP21007
26,8 kg.

CAACP21008
26.20 kg.

180
210

212 L.



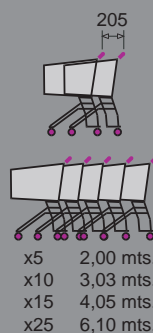
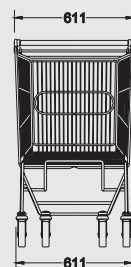
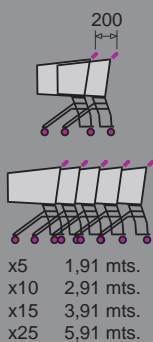
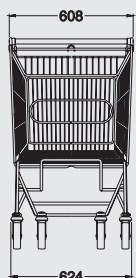

240 L.



ROUES WHEELS





212

PORTE-BÉBÉ
 BABY SEAT
 SANS
 WITHOUT 
 AVEC
 WITH 

CAASP21203 25,05 kg.	CAASP21206 25,25 kg.	CAASP21207 25,65 kg.	CAASP21208 25,05 kg.
CAACP21203 26,55 kg.	CAACP21206 26,75 kg.	CAACP21207 27,15 kg.	CAACP21208 26,55 kg.

240

PORTE-BÉBÉ
 BABY SEAT
 SANS
 WITHOUT 
 AVEC
 WITH 

CAASP24003 27,75 kg.	CAASP24006 27,95 kg.	CAASP24007 28,35 kg.	CAASP24008 27,75 kg.
CAACP24003 29,25 kg.	CAACP24006 29,45 kg.	CAACP24007 29,85 kg.	CAACP24008 29,25 kg.

80 L.

CHARIOT POUR PETITS ACHATS
LIGHT SHOPPING TROLLEY



100 L.

CHARIOT POUR PETITS ACHATS
LIGHT SHOPPING TROLLEY

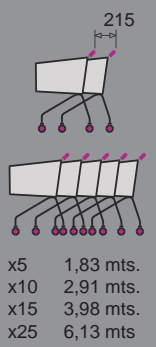
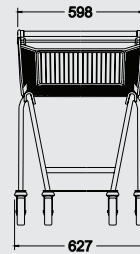
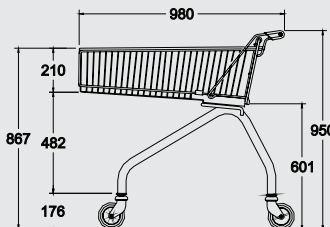
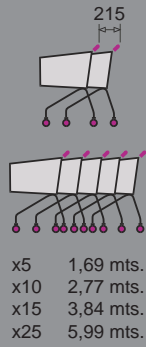
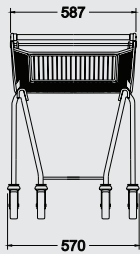
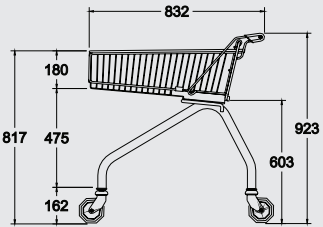

ROUES
WHEELS



3



6



7



8

80

CCLSP08003
18,70 kg.

CCLSP08006
18,80 kg.

CCLSP08007
19,20 kg.

CCLSP08008
18,70 kg.

100

CCLSP10003
18,45 kg.

CCLSP10006
18,65 kg.

CCLSP10007
19,05 kg.

CCLSP10008
18,45 kg.

200 L.

CHARIOT AVEC OUVERTURE FRONTALE RABATTABLE
EASY CHECK-OUT TROLLEY



212 L.

CHARIOT " T-M "

" T-M " TROLLEY

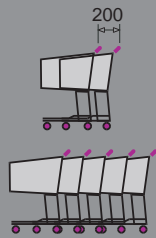
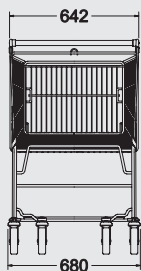
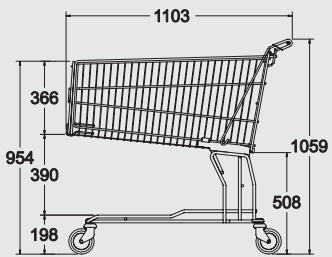

- x5 1,83 mts.
- x10 2,83 mts.
- x15 3,83 mts.
- x25 5,83 mts.

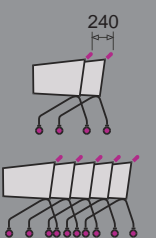
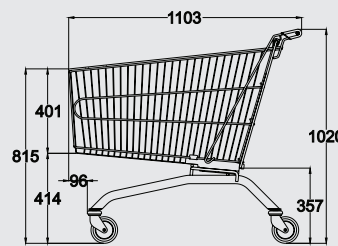

- x5 2,06 mts.
- x10 3,26 mts.
- x15 4,46 mts.
- x25 6,86 mts.

ROUES
WHEELS



3



6



7



8

200

PORTE-BÉBÉ
BABY SEAT

SANS
WITHOUT



AVEC
WITH



CASSPAF203
29,3 kg.

CASSPAF206
29,3 kg.

CASSPAF207
29,8 kg.

CASSPAF208
29,1 kg.

CASCPAF203
30,8 kg.

CASCPAF206
30,8 kg.

CASCPAF207
31,3 kg.

CASCPAF208
30,6 kg.

212

PORTE-BÉBÉ
BABY SEAT

SANS
WITHOUT



AVEC
WITH



CAALSP21203
21,70 kg.

CAALSP21206
21,50 kg.

CAALSP21207
22,30 kg.

CAALSP21208
21,70 kg.

CAALCP21203
23,20 kg.

CAALCP21206
23,00 kg.

CAALCP21207
23,80 kg.

CAALCP21208
23,20 kg.

120 L.

CHARIOT SKALATOR
SKALATOR TROLLEY



140 L.

CHARIOT SKALATOR
SKALATOR TROLLEY

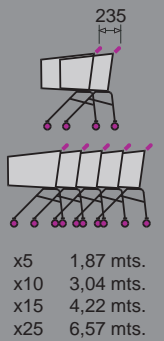
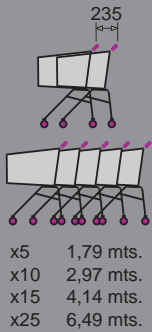
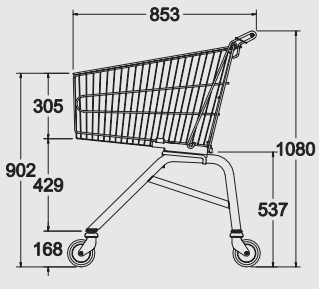

ROUES WHEELS



PORTE-BÉBÉ
BABY SEAT



SANS
WITHOUT

AVEC
WITH

CAK0012003
18,45 kg.

CAPK012003
19,95 kg.

CAK0012006
18,25 kg.

CAPK012006
19,75 kg.

CAK0012007
19,05 kg.

CAPK012007
20,55 kg.

CAK0012008
18,45 kg.

CAPK012008
19,95 kg.

PORTE-BÉBÉ
BABY SEAT



SANS
WITHOUT

AVEC
WITH

CAK0014003
19,65 kg.

CAPK014003
21,15 kg.

CAK0014006
19,45 kg.

CAPK014006
20,95 kg.

CAK0014007
20,25 kg.

CAPK014007
21,75 kg.

CAK0014008
19,65 kg.

CAPK014008
21,15 kg.

120

140

140 L.

CHARIOT " E-M " " E-M " TROLLEY



62 L.

CHARIOT "PMR" HANDICAPPED TROLLEY

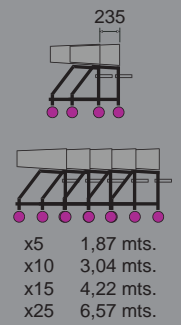
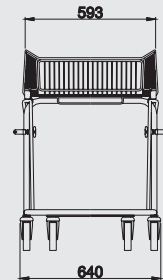
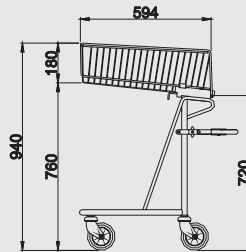
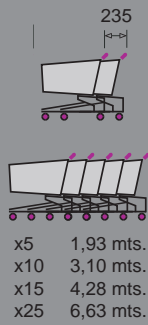
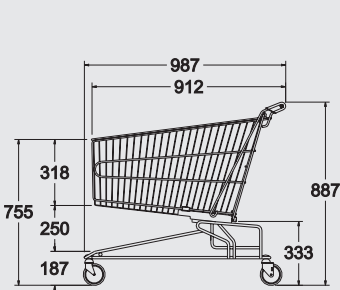

ROUES
WHEELS



140

CAEM1406-7
26,0 kg.

CAEM1407-8
26,0 kg.

62

CAMV6203
14,45 kg.

CAMV6206
14,65 kg.

CAMV6207
15,05 kg.

CAMV6208
14,45 kg.



CHARIOT DEUX PANIERS

MULTI-BASKET TROLLEY

- x5 1,61 mts.
- x10 2,56 mts.
- x15 3,51 mts.
- x25 5,41 mts.

PETIT
SMALL

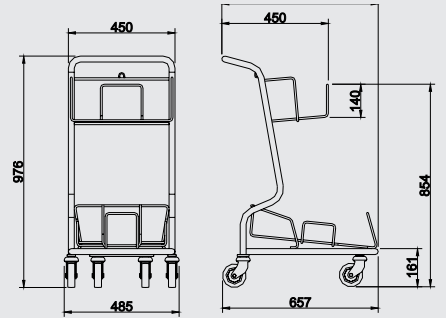

CMCP02

CMCP02-2F



CMCG02

CMCG02-2F



GRAND
LARGE

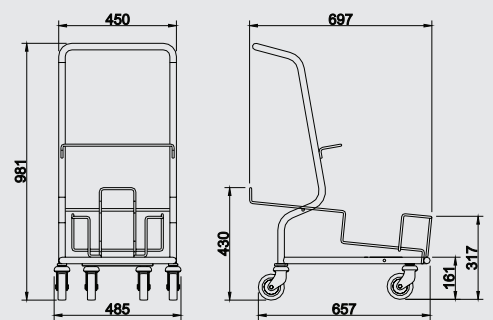

- x5 1,61 mts.
- x10 2,56 mts.
- x15 3,51 mts.
- x25 5,41 mts.



25 L.



PANIER

SHOPPING BASKET

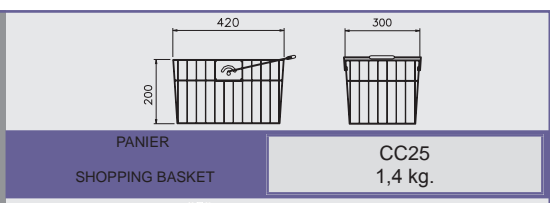
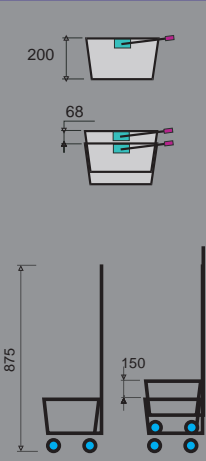

PANIER
SHOPPING BASKET

CC25
1,4 kg.

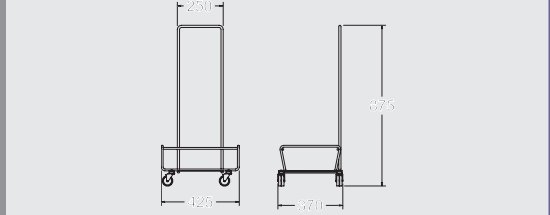

CHARIOT POUR RANGEMENT DE PANIERS
BASKET STACKING TROLLEY

CPCC25
6,0 Kg.



50 L.

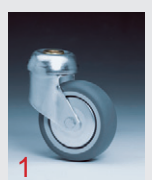
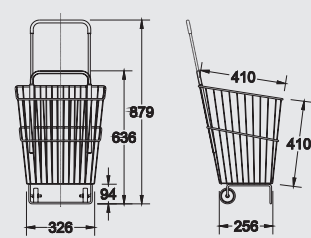
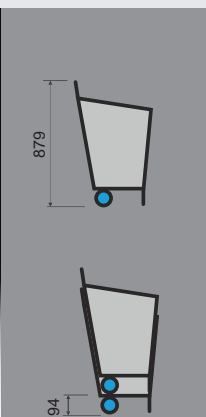

CC5001
1,4 Kg.

STD



	50	60	80	100	120	140	150	160	180	210	212	240
GRILLE INFÉRIEURE GRILL BASE RPCA80 RPCA100 RPCA120 RPCA140 RPCA150 RPCA160 RPCA180 RPCA210 RPCA212 RPCA240			●	●	●	●	●	●	●	●	●	●
PROFILS DE CORNIÈRE DE PROTECTION PVC PLASTIC PROTECTORS CPC50 CPC60 CPC80 CPC100 CPC120 CPC140 CPC150 CPC160 CPC180 CPC210 CPC212 CPC240	●	●	●	●	●	●	●	●	●	●	●	●
CORNIÈRES DE PROTECTION D'ANGLES CORNER PROTECTORS CPEC	●	●	●	●	●	●	●	●	●	●	●	●
PETITE CLOISON DE SÉPARATION BASKET DIVIDER SPCA180 SPCA210 SPCA212 SPCA240									●	●		
CLOISON DE SÉPARATION VERTICAL BASKET DIVIDER SCA120 SCA140 SCA150 SCA160 SCA180 SCA210 SCA212 SCA240					●	●	●	●	●	●	●	●
DOUBLE PORTE-BÉBÉ TWIN BABY SEAT DPBI									●	●	●	●
PORTE-BÉBÉ DOUBLE FONCTION DOUBLE FONCTION BABY SEAT PBPDFI						●	●	●	●	●	●	●
SUPPORT PACKS FIXE FIXED BOTTLE RACK RBF240												●
SUPPORT PACKS PLIABLE FOLDING BOTTLE RACK												
CROCHET PORTE SAC PVC EXTÉRIEUR PLASTIC BAG HOOK GBCA	●	●	●	●	●	●	●	●	●	●	●	●
SUPPORT PUBLICITAIRE ADVERTISEMENT HOLDER PCPCA80160 PCPCA180240			●	●	●	●	●	●	●	●	●	●
COQUE BÉBÉ BABY CRADLE CCBD						●	●	●	●	●	●	●
CORBILLE SUPPORT COQUE BÉBÉ WIRE CRADLE FOR NEWBORN CAR SEAT CSCM									●	●	●	●



80	100	120	140	150	160	180	210	212	240
●	●	●	●	●	●	●	●	●	●
●	●	●	●	●	●	●	●	●	●
						●	●		
		●	●	●	●	●	●	●	●
						●	●	●	●
			●	●	●	●	●	●	●
●	●	●	●	●	●	●	●	●	●
●	●	●	●	●	●	●	●	●	●
			●	●	●	●	●	●	●
						●	●	●	●

GRILLE INFÉRIEURE
GRILL BASE

PROFILS DE CORNIÈRE DE PROTECTION PVC
PLASTIC PROTECTORS
CPC50 CPC60 CPC80
CPC100 CPC120 CPC140
CPC150 CPC160 CPC180
CPC210 CPC212 CPC240

CORNIÈRES DE PROTECTION D'ANGLES
CORNER PROTECTORS
CPEC

PETITE CLOISON DE SÉPARATION
BASKET DIVIDER
SPCA140 SPCA150 SPCA160
SPCA180 SPCA210 SPCA212
SPCA240

CLOISON DE SÉPARATION
VERTICAL BASKET DIVIDER
SCA140 SCA150 SCA160
SCA180 SCA210 SCA212
SCA240

DOUBLE PORTE-BÉBÉ
TWIN BABY SEAT
DPBI

PORTE-BÉBÉ DOUBLE FONCTION
DOUBLE FONCTION BABY SEAT
PBPDFI

SUPPORT PACKS FIXE
FIXED BOTTLE RACK
RBF1821
RBF1416

SUPPORT PACKS PLIABLE
FOLDING BOTTLE RACK
RB1821

CROCHET PORTE SAC PVC
EXTÉRIEUR
PLASTIC BAG HOOK
GBCBA

SUPPORT PUBLICITAIRE
ADVERTISEMENT HOLDER
PCPCA80160
PCPCA180240

COQUE BÉBÉ
BABY CRADLE
CCBD

CORBILLE SUPPORT COQUE BÉBÉ
WIRE CRADLE FOR NEWBORN
CAR SEAT
CSCM

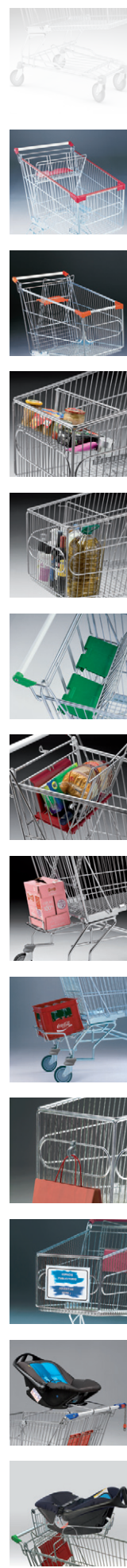

SPC



	80 PETITS ACHATS LIGLIGHT SHOPPING TROLLEY	100 PETITS ACHATS LIGLIGHT SHOPPING TROLLEY	200 OUVERTURE FRONTALE RABATTABLE EASY CHECK-OUT TROLLEY	212 CHARIOT "T-M" "TM" TROLLEY	120 SKALATOR	140 SKALATOR	140 CHARIOT "E-M" "E-M" TROLLEY	62 CHARIOT "PMR" HANDICAPPED TROLLEY
GRILLE INFÉRIEURE GRILL BASE RPCA140 (200) RPCA212			●					
PROFILS DE CORNIÈRE DE PROTECTION PVC PLASTIC PROTECTORS CPC80 CPC100 CPC120 CPC140 CPC212	●	●		●	●	●	●	
CORNIÈRES DE PROTECTION D'ANGLES CORNER PROTECTORS CPEC	●	●		●	●	●	●	
PETITE CLOISON DE SÉPARATION BASKET DIVIDER								
CLOISON DE SÉPARATION VERTICALE VERTICAL BASKET DIVIDER SCA140 SCA212				●		●	●	
DOUBLE PORTE-BÉBÉ TWIN BABY SEAT DPBI				●				
PORTE-BÉBÉ DOUBLE FONCTION DOUBLE FONCTION BABY SEAT PBPDFI			●	●				
SUPPORT PACKS FIXE BOTTLE RACK RBF8010	●	●						
SUPPORT PACKS Pliable FOLDING BOTTLE RACK RB212				●				
CROCHET PORTE SAC PVC EXTÉRIEUR PLASTIC BAG HOOK GBCA	●	●		●	●	●	●	
SUPPORT PUBLICITAIRE ADVERTISEMENT HOLDER PCPCA80160 PCPCA180240				●	●	●	●	
COQUE BÉBÉ BABY CRADLE CCBD				●				
CORBEILLE SUPPORT COQUE BÉBÉ WIRE CRADLE FOR NEWBORN CAR SEAT CSCM				●				



Le parking est le premier contact visuel de votre magasin avec votre clientèle et le principal reflet de votre enseigne. Nos abris à chariots personnalisés renforceront l'image de votre magasin et s'intégreront dans votre environnement. Consultez-nous pour des réalisations sur mesures.

The trolleys shelter is the first contact of your business by the client, and the principal of your brand. These customized trolley shelters reinforce the image of your store according to its environment. Contact us for special request on measures.



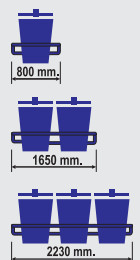
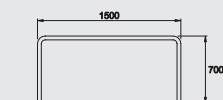
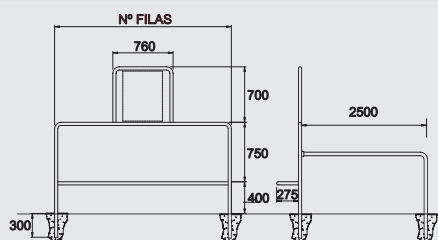
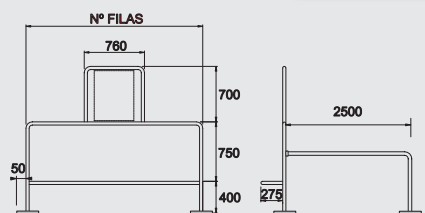
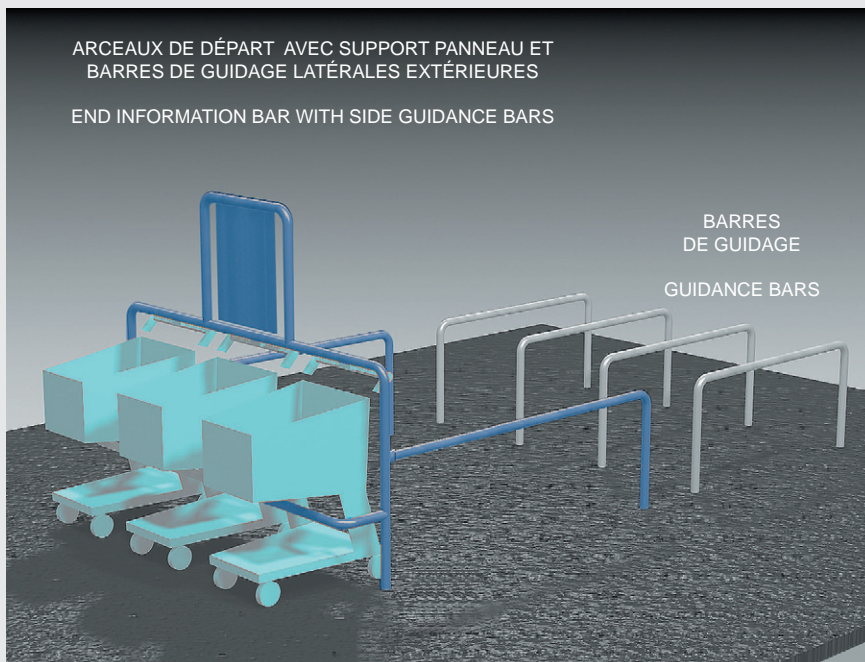
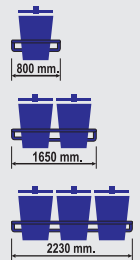
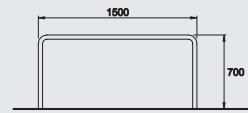
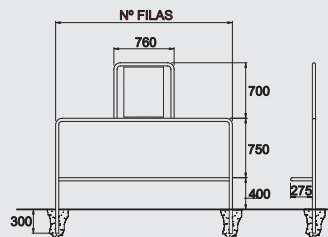
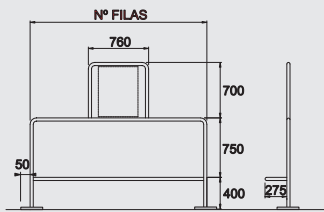
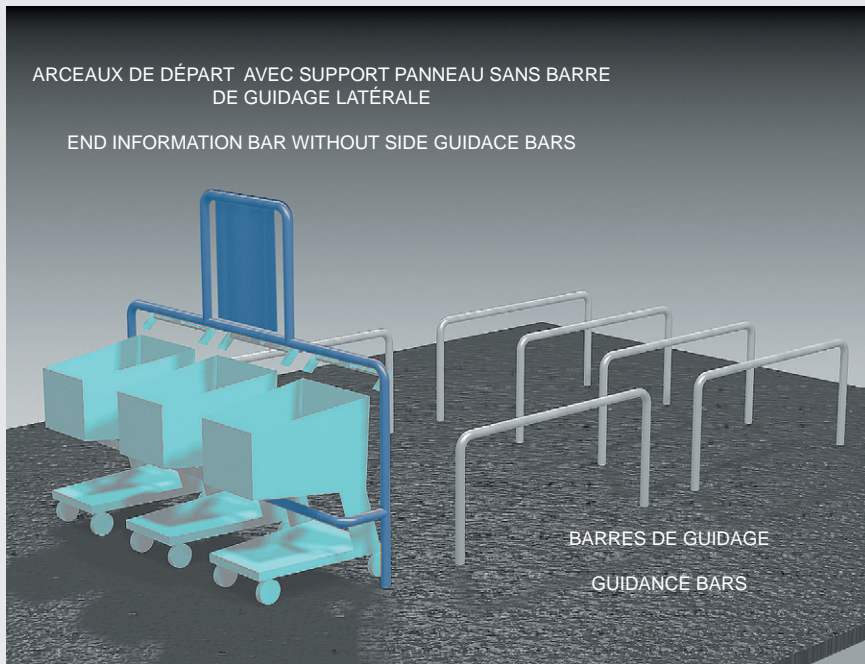



AENOR Asociación Española de
Normalización y Certificación

CERTIFICADO AENOR DE PRODUCTO N° A12 / 000001
AENOR PRODUCT CERTIFICATE N°

Pg. 1/13
2014-02-03

La Asociación Española de Normalización y Certificación (AENOR) certifica que el producto
The Spanish Association for Standardisation and Certification (AENOR) certifies that the product

**CARROS DE COMPRA METÁLICOS PARA USUARIOS DE SUPERMERCADO E
HIPERMERCADO**

METALLIC BASKET TROLLEYS FOR SUPERMARKET USERS

detallado en la(s) página(s) siguiente(s), detailed in the following page(s),
suministrado por supplied by

CREACIONES MARSANZ, S.A.
CL HIERRO, 27
28850 TORREJON DE ARDOZ (Madrid - ESPAÑA)

y elaborado en and manufactured in

CL HIERRO, 27
28850 TORREJON DE ARDOZ (Madrid - ESPAÑA)

es conforme con complies with

UNE-EN 1929-1:1998 (EN 1929-1:1998)
UNE-EN 1929-2:2005 (EN 1929-2:2004)
UNE-EN 1929-3:2005 (EN 1929-3:2005)
UNE-EN 1929-4:2005 (EN 1929-4:2005)
UNE-EN 1929-7:2005 (EN 1929-7:2005)

Para conceder este Certificado, AENOR ha ensayado el producto y ha comprobado el sistema de la calidad aplicado para su elaboración. AENOR realiza estas actividades periódicamente mientras el Certificado no haya sido anulado, según se establece en el Reglamento Particular RP A12.01.

In order to grant this Certificate, AENOR has tested the product and has verified the quality system used in its manufacture. AENOR performs these tasks periodically while the Certificate has not been cancelled, in accordance with the stipulations of the Specific Rules RP A12.01.

Fecha de concesión: **2004-02-03**
First issued on:

Fecha de renovación: **2014-02-03**
Renewed on:

Fecha de caducidad: **2019-02-03**
Expires on:

AENOR Asociación Española de
Normalización y Certificación

Avelino BRITO MARQUINA
Director General de AENOR/ Chief Executive Officer

No está autorizada la reproducción parcial de este documento.

The partial reproduction of this document is not permitted.

AENOR - Génova, 6 - 28004 MADRID - Teléfono 914 32 60 00 - Telefax 913 10 46 83

www.marsanz.es



SIÈGE

HEAD OFFICE

CALLE HIERRO, 27
28850 TORREJON DE ARDOZ
MADRID
ESPAÑA - SPAIN

TEL.: (34) 91 675 14 34 // (34) 91 677 10 92
FAX.: (34) 91 675 12 90
E.MAIL.: creaciones@marsanz.es

USINES
PRODUCTION FACILITIES

TORREJON DE ARDOZ (MADRID)
UGENA (TOLEDO)

INTERNATIONAL

EXPORT DIVISION

E.MAIL.: export@marsanz.es

www.marsanz.es

FRANCE

MARSANZ FRANCE SAS

13 RUE SAINT HONORÉ
78000 VERSAILLES

TEL.: +33 (0) 1 30 88 82 95
E.MAIL.: info@marsanz.fr
www.marsanz.fr

ROYAUME UNI

UNITED KINGDOM

MARSANZ UK Ltd.

28 ST CLEMENTS ROAD
MANCHESTER, M21 9HU

TEL.: +44 (0) 1618818515
E.MAIL.: info@marsanz.co.uk
www.marsanz.co.uk

BUREAUX REGIONAUX EN ESPAGNE

SPANISH BRANCHES

BARCELONA

POLIGONO INDUSTRIAL MOLI D'EN XECH
Calle Barneda, Nº 17 nave 25
Frente Rio Ripoll
08291 - RIPOLLET

TEL.: 93 231 34 75
FAX.: 93 231 35 47
E.MAIL.: barcelona@marsanz.es

SEVILLA

AVDA. DEL PARSÍ
POL.IND. MINI PARSÍ, NAVE 9
41016 SEVILLA

TEL.: 95 451 12 45
FAX.: 95 425 85 09
E.MAIL.: andalucia@marsanz.es

ALICANTE

C/ CAMPELLO, 13
POL.IND. LA CALA
03509 FINESTRAT - ALICANTE

TEL.: 96 680 27 04
FAX.: 96 683 07 96
E.MAIL.: levante@marsanz.es

DISTRIBUÉ PAR

DISTRIBUTED BY

FR

EN

La Marsanz

www.marsanz.es



1